

Fenster & Türen *Welt*[®]

| MEHR ALS SIE ERWARTEN |



INNENTÜREN-KATALOG

Willkommen!

Lassen Sie sich inspirieren!

Gestalten Sie Ihr Zuhause nach Ihrem ganz persönlichen Wohnstil. Möbel, Teppiche, Bilder und Wohnaccessoires gehören ebenso zum Gesamteindruck wie Innentüren.

Sie haben die Wahl: Ob klassische Kassetentüren für den Altbau, stylische Designtüren für einen modernen Look, wohnliche Holztüren für ein natürliches Raumgefühl oder Glastüren mit edlen Lichteffekten als charmanter Blickfang – unsere Türen lassen kaum Wünsche offen und passen sich spielend an Ihren individuellen Wohnraum an.

Holen Sie sich auch Ideen, Inspirationen und Tipps in unseren Ausstellungen in Stuhr und Braunschweig. Selbstverständlich stehen wir Ihnen mit unserer Erfahrung, technischem Knowhow und unserem qualifizierten Aufmaß- und Montageservice zur Seite. Wir freuen uns auf Ihren Besuch.

Ihr Team der Fenster & Türen Welt

INHALT

Weißlack 1.0 Seite 6

Weißlack 3.0 Seite 28

Mineralgrau Seite 38

Designoberflächen Seite 48

Echtholz Seite 62

Lisenen Seite 72

Stumpfeinschlagend Seite 76

Glas Seite 80

Türsysteme Seite 112

Beschläge Seite 128

Funktionen & Erweiterungen Seite 150

Wissenswertes Seite 162





WEISSLACK 1.0

Weiß passt einfach immer – schlicht, zeitlos elegant und seit jeher Trend beim Einrichten und Wohnen. Es schafft Ruhe, Leichtigkeit und Weite im Raum. Nicht umsonst sind Weißlack 1.0 Türen derart gefragt. Unser Weißton in Anlehnung an RAL 9010 fügt sich zurückhaltend und harmonisch in jeden Wohnraum ein. Das vielfältige Weißlack 1.0 Sortiment, angefangen von schlichten glatten Türen über Designtüren bis hin zu modernen oder klassischen Stiltüren, wahlweise auch mit Lichtausschnitten oder Lisenen – bietet eine große Auswahl für jeden Wohnstil.

Besonders gut harmoniert der Farbton Weißlack 1.0 mit gedämpften, weniger intensiven Wandfarben. Auch die Kombination mit Holzmaterialien sowie Erd- und Naturfarbtönen sorgt für ein stimmiges Erscheinungsbild und eine Wohlfühlatmosphäre.

GLATTE TÜREN
WEISSLACK 1.0

WEISSLACK 1.0

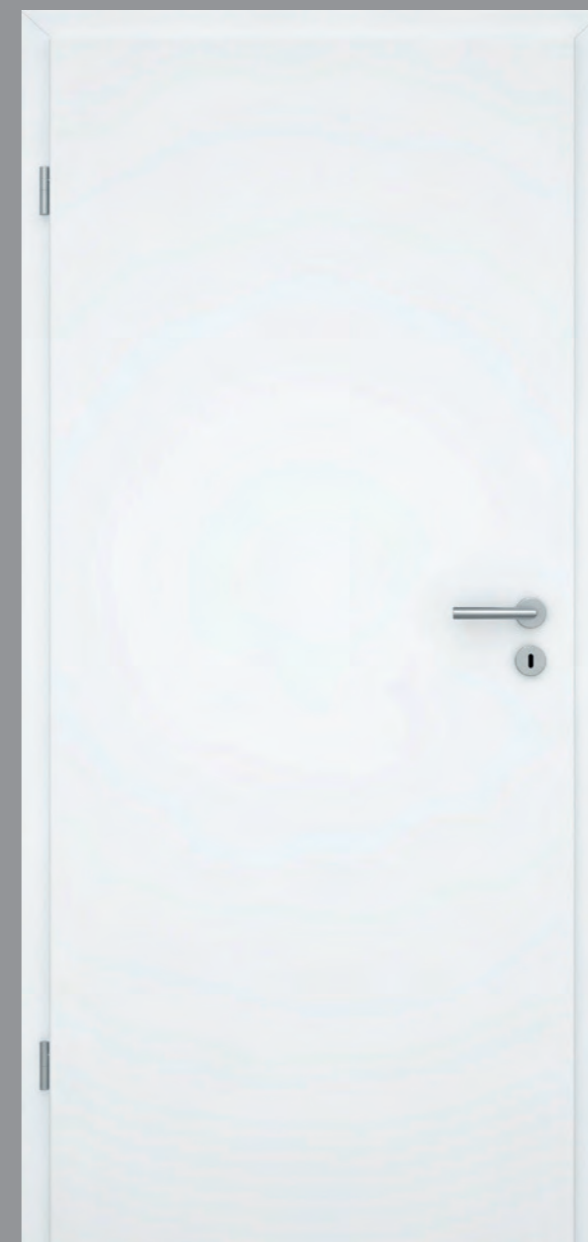

Glatte Tür Weißlack 1.0

VARIANTEN MIT GLAS



LA XL



LA 001



LA DIN



LA 008 M



LA 002



LA 003



LA 004



LA 005



LA 006



LA 008 B



LA 008 S



CPL



Glatt



Rund- oder Designkante



Röhrenspannern

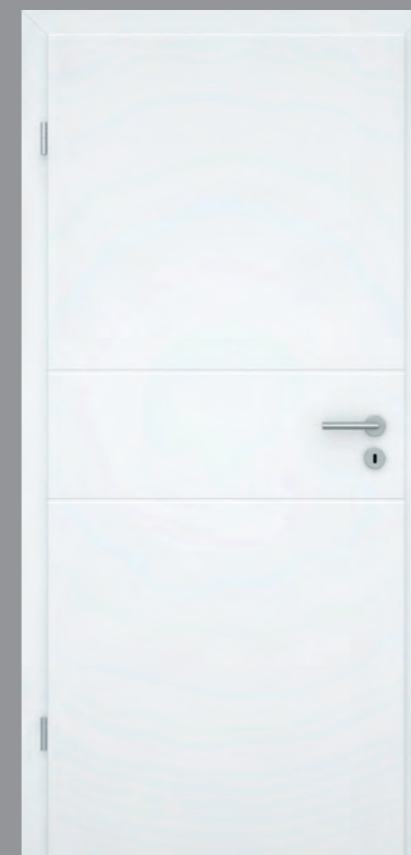

Verona VO3

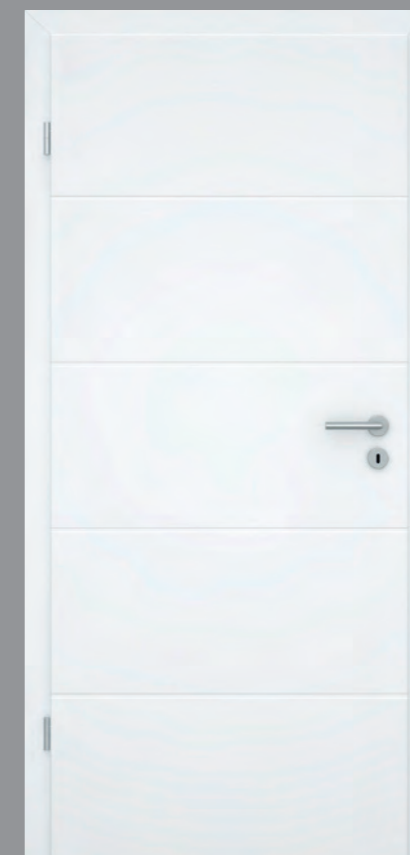

Verona VO5

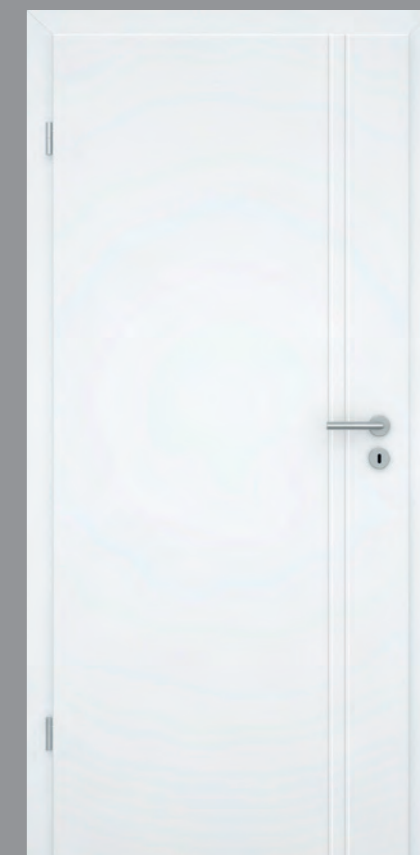

Verona VO7

VARIANTEN MIT GLAS



VO3 LA 008 B



VO3 LA 008 M



VO3 LA 008 S



VO3 LA 001



VO7 LA 008 B



VO7 LA 008 M



VO5 LA 008 B



VO5 LA 008 M



VO5 LA 008 S



VO5 LA 001

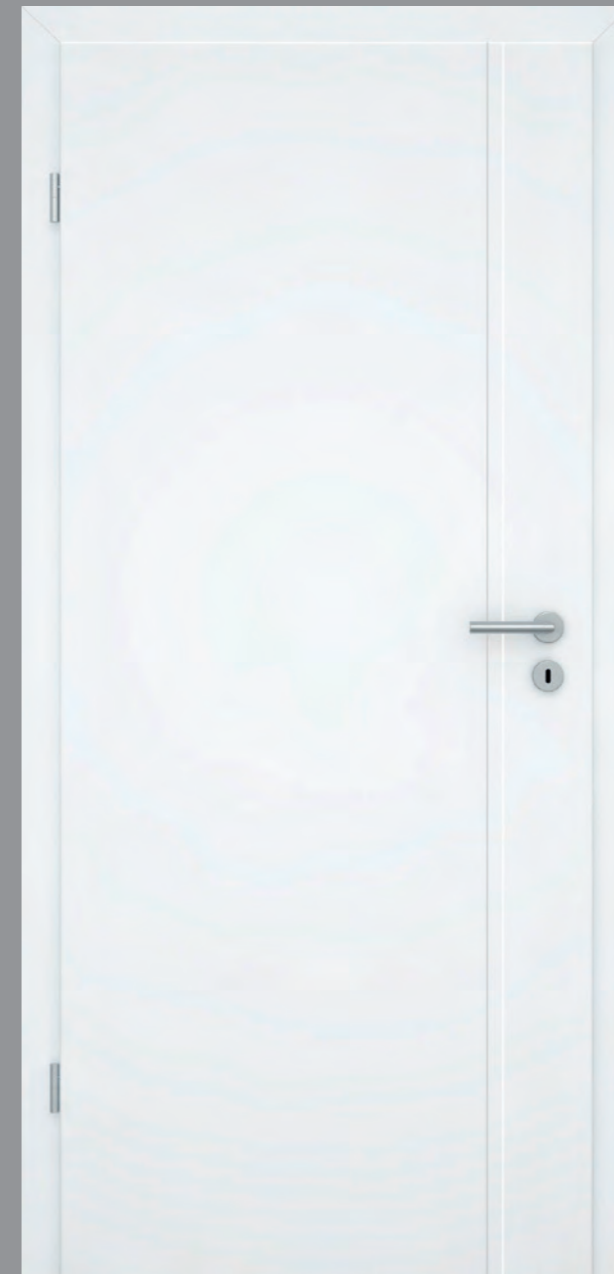

Siena SF1

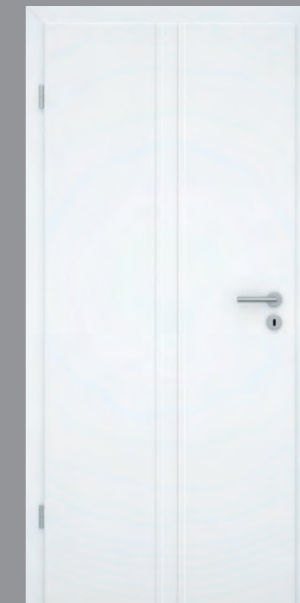

Siena SF2



Siena SF3

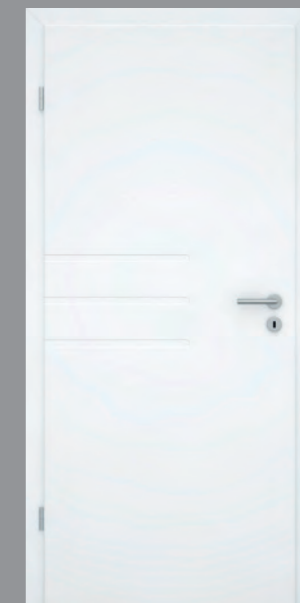

Siena SF4

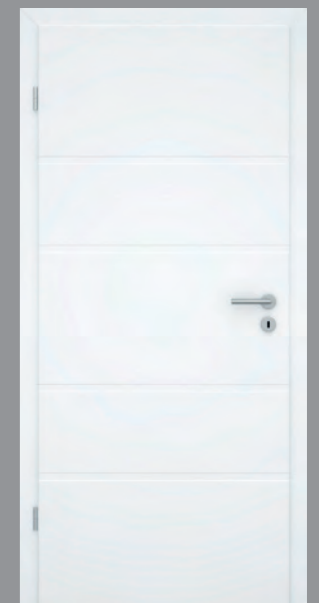

Siena SF5

VARIANTEN MIT GLAS



SF3 LA 008 B



SF3 LA 008 M



SF3 LA 008 S



SF3 LA 001

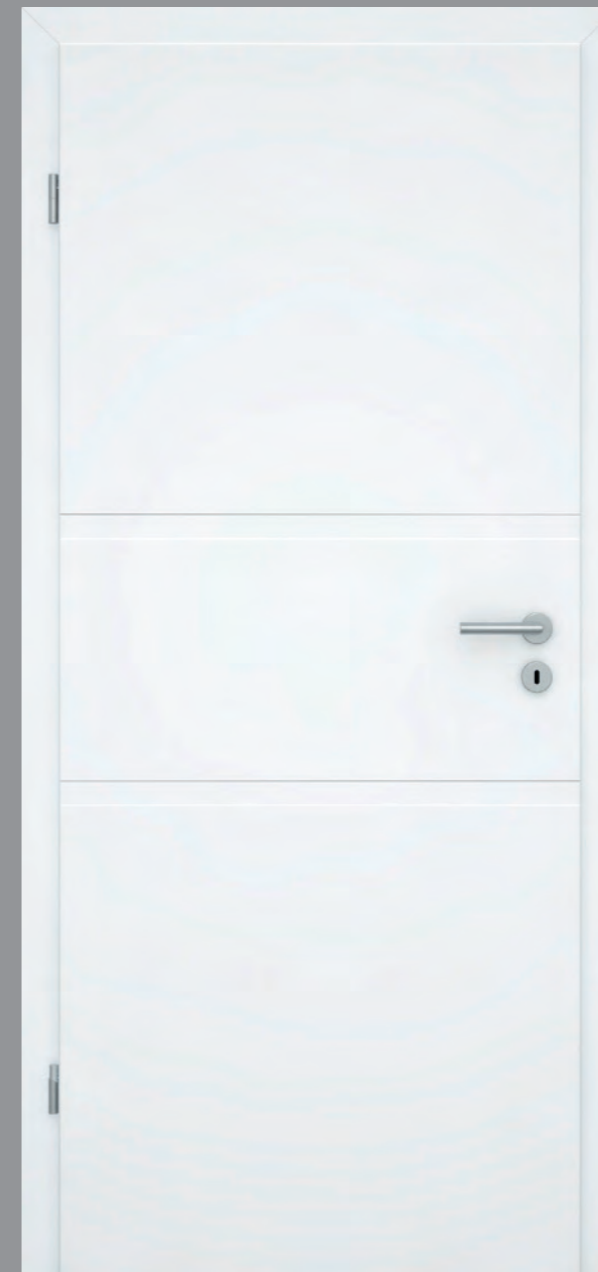

Modena MO3

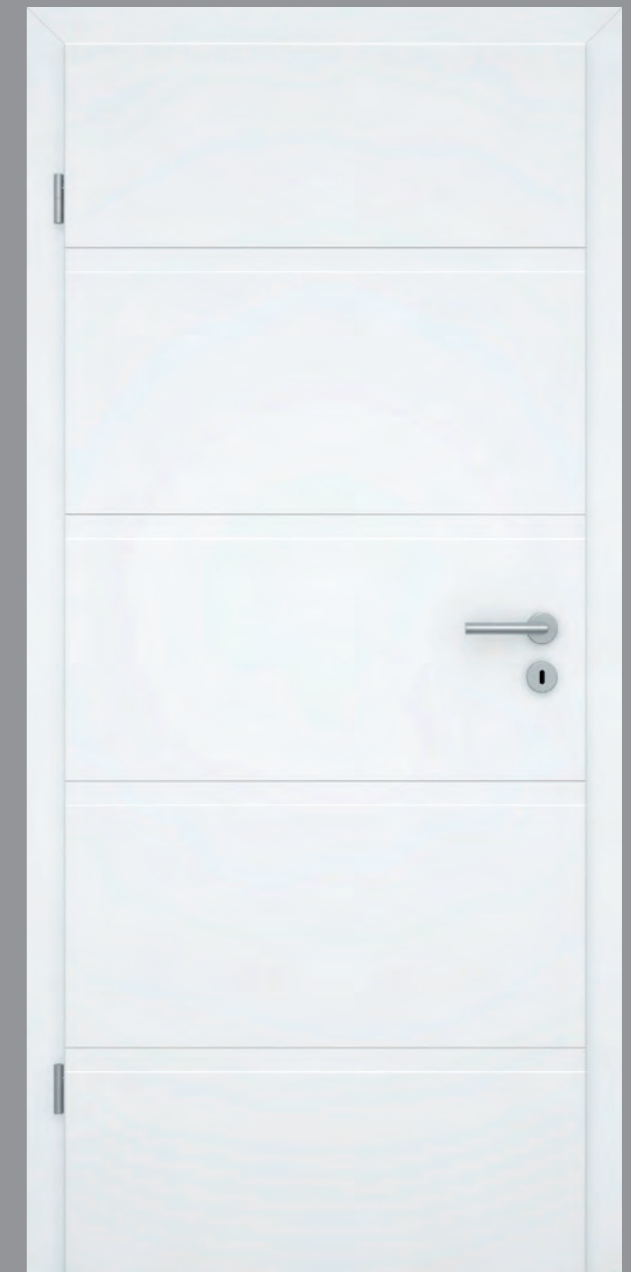

Modena MO5

VARIANTEN MIT GLAS



MO5 LA 008 B MO5 LA 008 M MO5 LA 008 S MO5 LA 001

KONTURTÜREN SALERNO

WEISSLACK 1.0



Salerno SA05



SA02



SA12



SA07



Mit Premium-Zarge ohne sichtbare Gehrungsfuge erhältlich.

VARIANTEN MIT GLAS:



SA02 LA008 B



SA02 LA008 M



SA02 LA008 S



SA05 LA008 B



SA05 LA008 M



SA05 LA008 S

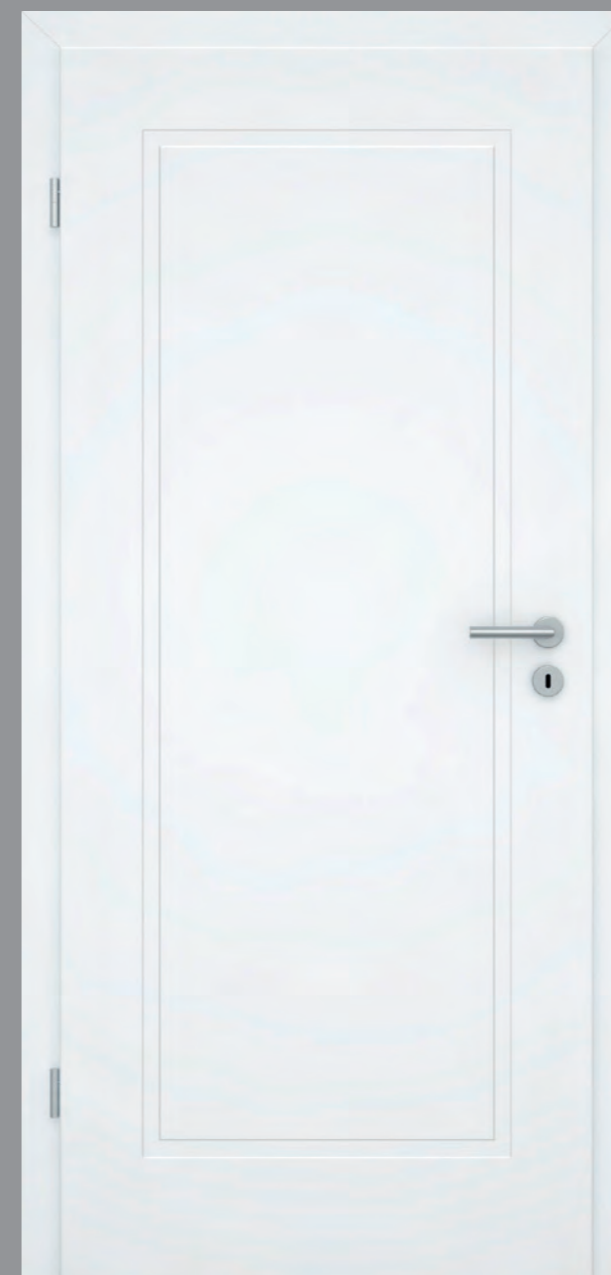

Novara 1G

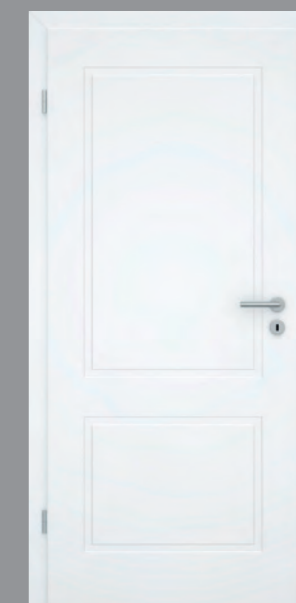

Novara 2G

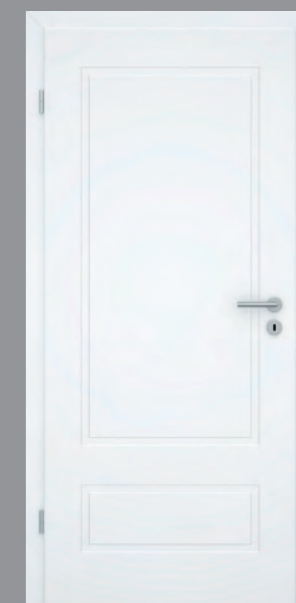

Novara 2G AD

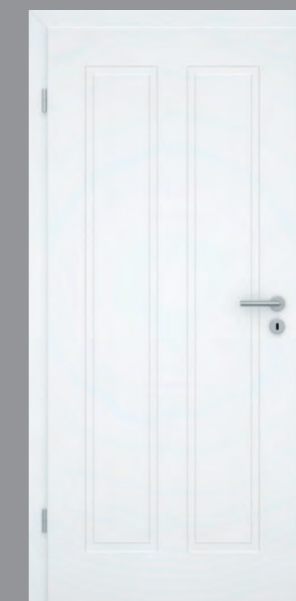

Novara 2G AD2

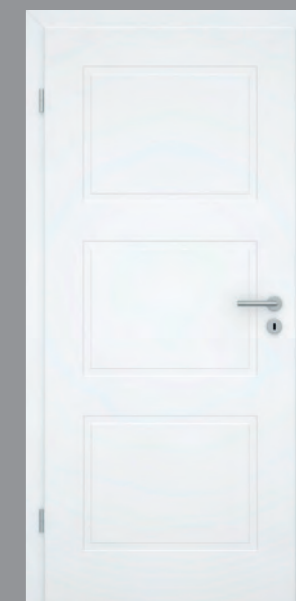

Novara 3G

VARIANTEN MIT GLAS



1G LA



2G LA



2G AD LA



2G AD2 2LA



3G 1LA



3G 2LA



3G 3LA

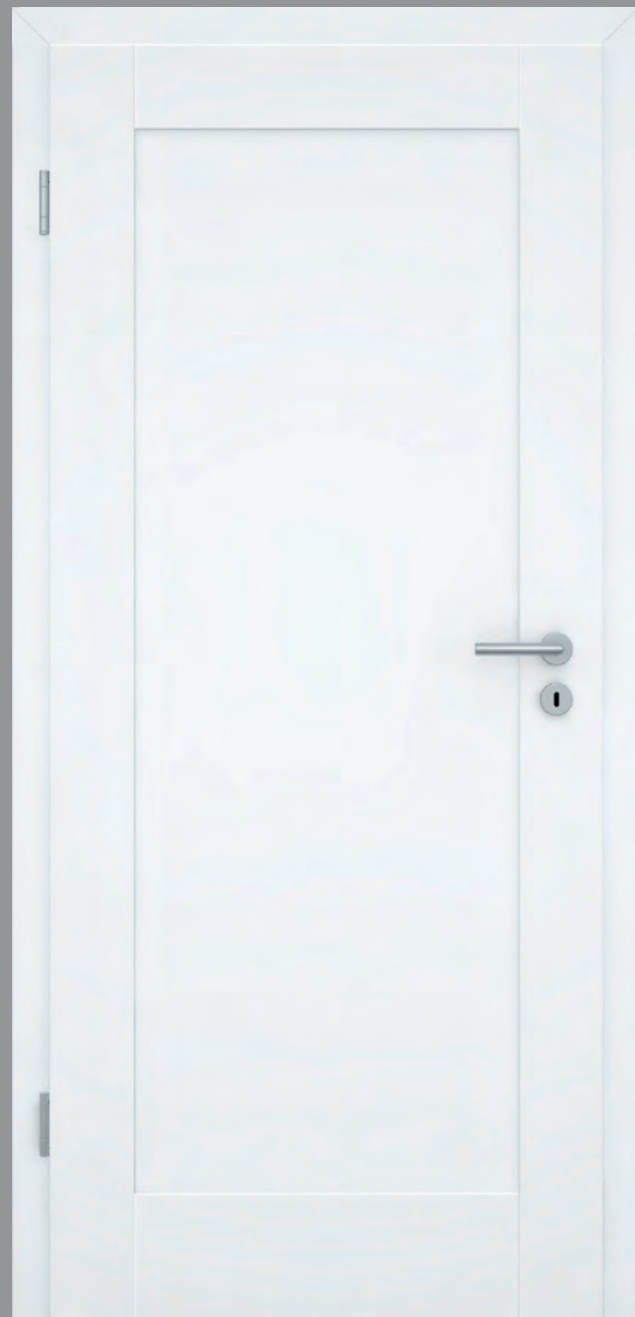

Flensburg 1G



2G AD2

2G

2G OF2

3G

4G

4G OF1



Mit Premium-Zarge ohne sichtbare Gehrungsfuge erhältlich.

VARIANTEN MIT GLAS



2G AD2 2LA

2G LA

2G LA SP6

2G LA SP9

2G OF2 2LA

3G 1LA

3G 2LA

3G 3LA

4G LA

4G 2LA

4G LA SP6

4G LA SP9



Flensburg 1G LA

AUCH MIT ECHTHOLZ-OBERFLÄCHE:



Ahorn

Buche

Eiche natur

Eiche astig

Kirschbaum



Kiel 2G

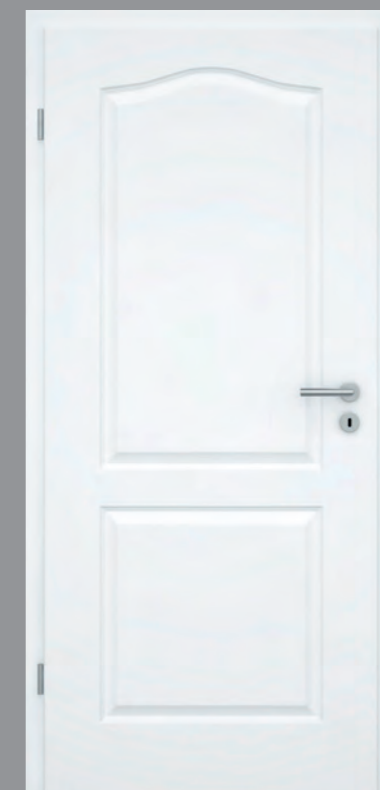

Kiel 2KB



Kiel 3G

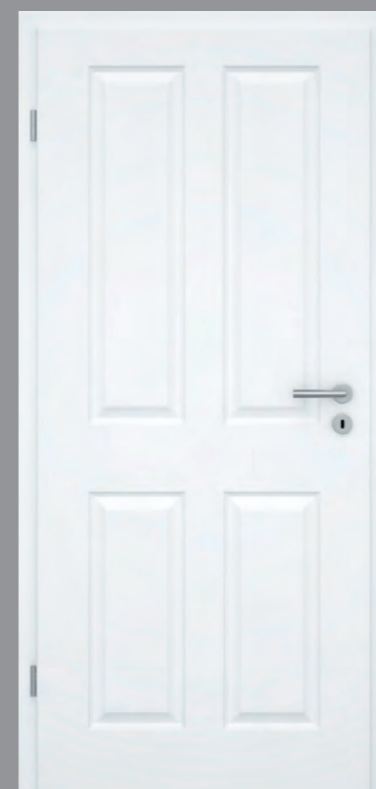

Kiel 4G



Kiel 4G AD

VARIANTEN MIT GLAS



2G LA



2G LA SP3



2G LA SP6



2G LA SP9



2KB LA



2KB LA SP3



2KB LA SP7



2KB LA SP6



2G LA SP als Doppeltür



4G LA



4G LA SP9



4G 2LA



4G 2LA SP5



4G AD 1LA



4G AD 3LA

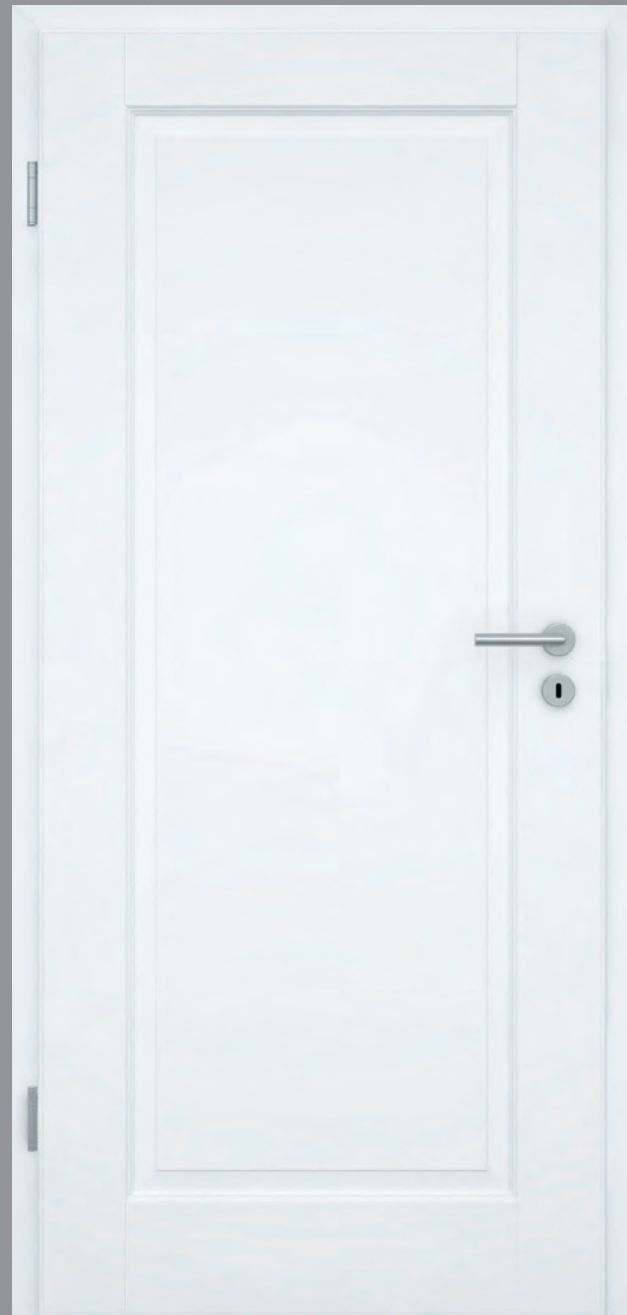

Kopenhagen 1G



2G 2G AD2 2G AD 2G OF2
3G 4G 4G AD 4G OF1
5G 6G



Mit Premium-Zarge ohne sichtbare Gehrungsfuge erhältlich.

VARIANTEN MIT GLAS:



1G LA 2G AD2 2LA 2G AD LA 2G AD LA SP8 2G LA
2G LA SP6 2G LA SP9 2G OF2 2LA 3G LA 3G LA SP4
4G LA 4G LA SP6 4G 2LA 4G 2LA SP5 4G AD 1LA
4G AD 3LA 5G LA 5G 2LA 6G 2LA

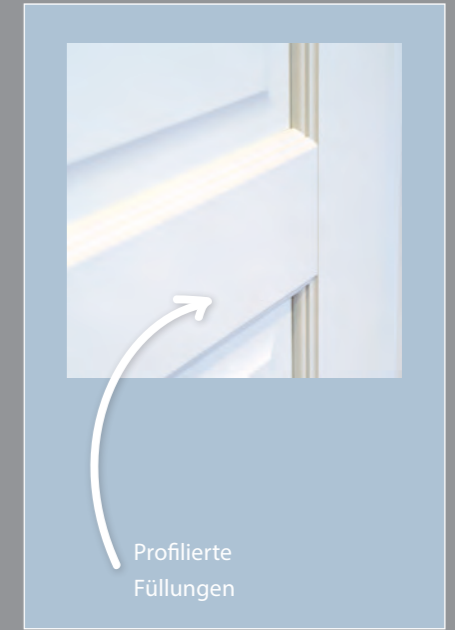

Profilierte Füllungen

AUCH MIT
ECHTHOLZ-OBERFLÄCHE:



Ahorn Buche Eiche natur
Eiche astig Kirschbaum



WEISSLACK 3.0

Weiß ist nicht gleich Weiß – dies trifft auch auf Türen zu. In der Wohngestaltung werden hochweiße Farbtöne zunehmend beliebter: Weißlack 3.0, in Anlehnung am Farbton RAL 9003, ist einer der weißesten Farbtöne für Innentüren und fügt sich bestens in jede Wohnumgebung ein. Strahlender und etwas kühler im Vergleich zum Weißlack 1.0, brilliert dieser Farbton besonders gut in modernen, hellen Räumen. Zudem bietet er einen optimalen Kontrast zur Wand- und Bodengestaltung und einzelnen Möbelstücken.

Egal ob schlichte glatte Türen, Designtüren oder Stiltüren, auch im Farbton Weißlack 3.0 steht eine breite Auswahl an Modellen und Varianten für jeden Wohnstil zur Verfügung.

GLATTE TÜREN
WEISSLACK 3.0

WEISSLACK 3.0



VARIANTEN MIT GLAS



Glatte Tür Weißlack 3.0



LA XL



LA 001



LA DIN



LA 008 M



LA 002



LA 003



LA 004



LA 005



LA 006



LA 008 B



LA 008 S



CPL



Glatt



Designkante



Röhrenspankern

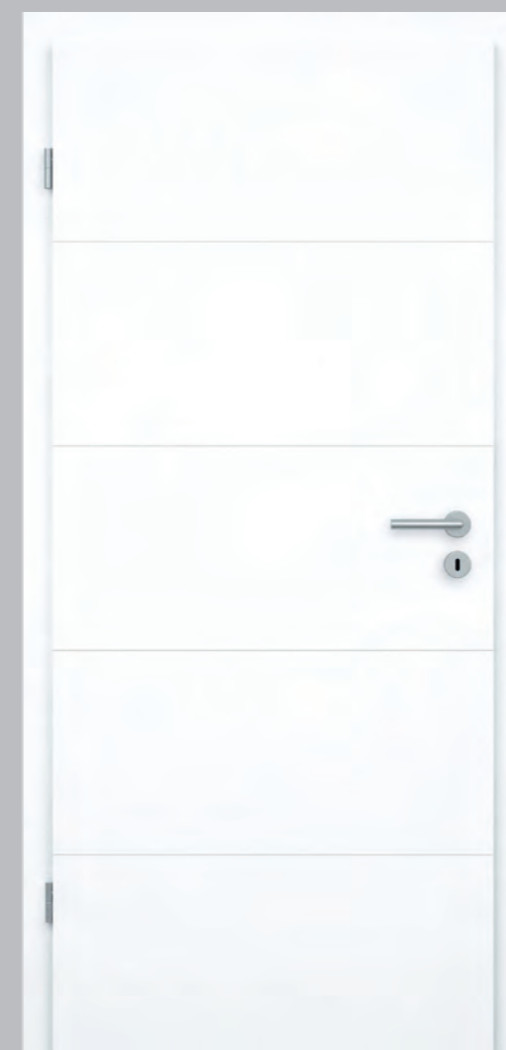

Genua GA5

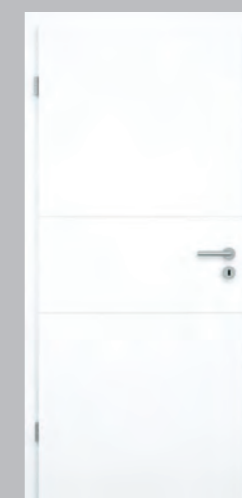

Genua GA3



Genua GA4



Genua GA6



Genua GA7



Genua GA8



Genua GA9

VARIANTEN MIT GLAS



GA3 LA008B



GA3 LA008M



GA3 LA008S



GA3 LA001



Bergamo 1G

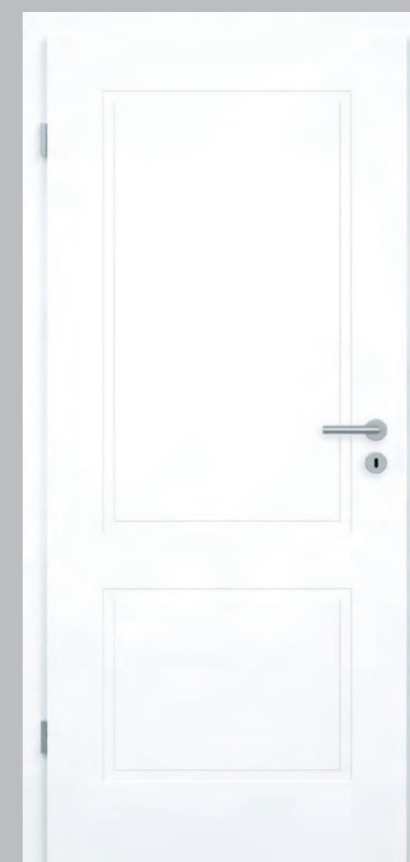

Bergamo 2G



Bergamo 3G

VARIANTEN MIT GLAS



1G LA



2G LA



3G 1LA



3G 2LA



3G 3LA



Lübeck 2G



Lübeck 4G

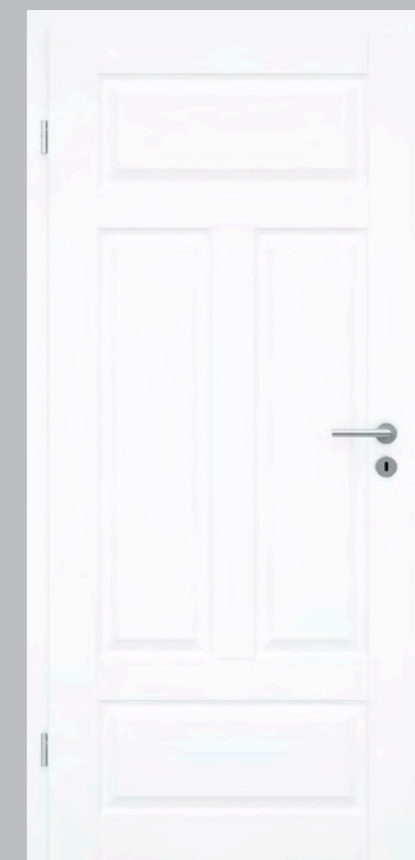

Lübeck 4G AD

VARIANTEN MIT GLAS



2G LA



2G LA SP6



4G LA



4G 2LA



2G LA SP9



4G LA SP9



4G AD 1LA



4G AD 3LA



MINERALGRAU

Vom Trendsetter zum Klassiker – graue Farbtöne sind seit jeher charakterstark und ästhetisch, auch in der Wohnlandschaft. Mineralgrau ist der zeitlose Farbton für Wohnraumtüren, der einerseits selbst für pure Eleganz steht, andererseits es versteht, sich charmant zurückzunehmen, um farbige Accessoires stilvoll in Szene zu setzen. Eine Farbe, deren Wärme sich auf angenehme Weise ausbreitet und absolute Wertigkeit vermittelt.

Eine Bandbreite an möglichen Türmodellen und -designs eröffnen diesem einzigartigen Farbton den Auftritt in jeder modernen und klassischen Wohnumgebung. Unsere Inspiration für ein schönes Zuhause!



Glatte Tür Mineralgrau

VARIANTEN MIT GLAS



LA XL



LA 001



LA DIN



LA 008 M



LA 002



LA 003



LA 004



LA 005



LA 006



LA 008 B



LA 008 S



Florenz FL3



Florenz FL5



Florenz FL6

VARIANTEN MIT GLAS



FL5 LA008B



FL5 LA008M



FL5 LA008S



FL5 LA001



Roma 1G



Roma 3G

VARIANTEN MIT GLAS



1G LA



3G 1LA



3G 2LA



3G 3LA

KLASSISCHE STILTÜREN
HAMBURG

MINERALGRAU



Hamburg 2G



Hamburg 4G



Hamburg 4G AD

VARIANTEN MIT GLAS



2G LA



2G LA SP6



4G LA



4G 2LA



2G LA SP9



4G LA SP9



4G AD 1LA



4G AD 3LA



DESIGNOBERFLÄCHEN

Schönes Design ist für die Ewigkeit! Unsere Designoberflächen sind eine Auswahl unterschiedlichster Holzdesigns, Farbtöne und Strukturen für Wohnraumtüren – von authentisch und natürlich bis hin zu markant und individuell. Ob Mattline mit feinen Holzmaserungen, Struktura mit lebendigen Holzstrukturen oder Colour mit modernen Unifarbtönen – die Kollektion an optischen und haptischen Highlights bietet für jeden Geschmack und Wohnstil ein passendes Design.

Ausgestattet mit einem robusten Material aus CPL-Schichtstoff (Continuous Pressure Laminate) halten Designoberflächen auch höchsten Ansprüchen in puncto Qualität und Pflegeleichtigkeit stand.

GLATTE TÜREN
CPL KLASSIK

DESIGNOBERFLÄCHEN



Esche weiß deckend

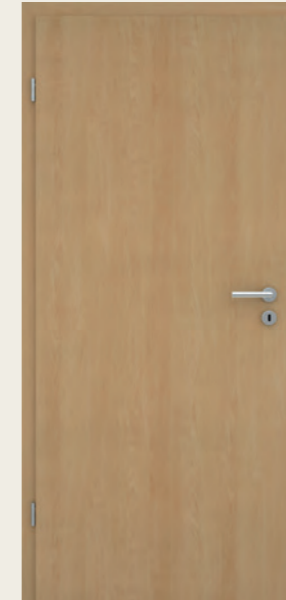

Ahorn

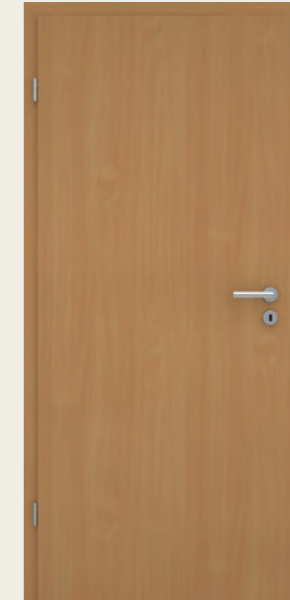

Buche



Akazie

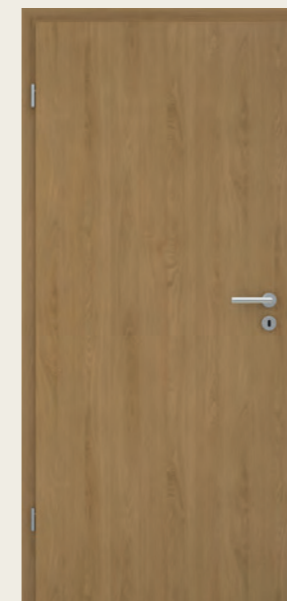

Eiche natur

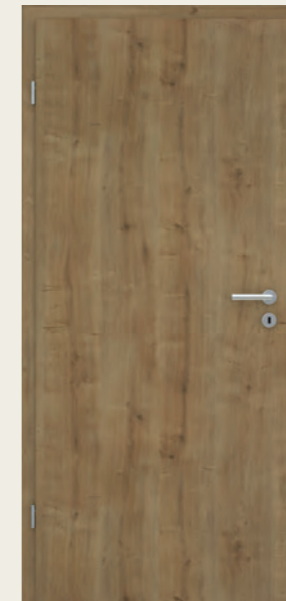

Eiche astig

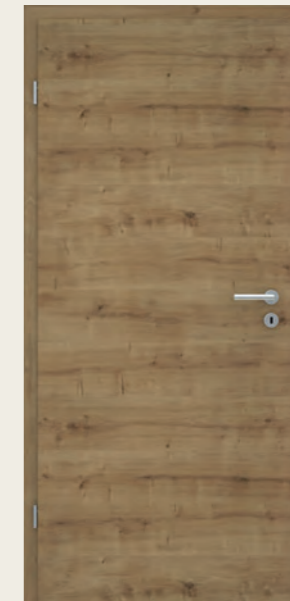

Eiche astig quer

VARIANTEN MIT GLAS



LA XL



LA 001



LA DIN



LA 002



LA 003



LA 004



LA 005



LA 006



LA 008 B



LA 008 M



LA 008 S



CPL



Feine Holzstruktur



Designkante



Röhrenspannern



GLATTE TÜREN
CPL STRUKTURA

DESIGNOBERFLÄCHEN



Pinie Ivory



Pinie Cream



Pinie Silvergrey



Pinie Ivory quer



Pinie Cream quer



Pinie Silvergrey quer



Fachwerk Eiche Sand



Fachwerk Eiche Natur



Fachwerk Eiche Honig



Fachwerk Eiche Sand quer



Fachwerk Eiche Natur quer



Fachwerk Eiche Honig quer

VARIANTEN MIT GLAS



LA XL



LA 001



LA DIN



LA 002



LA 003

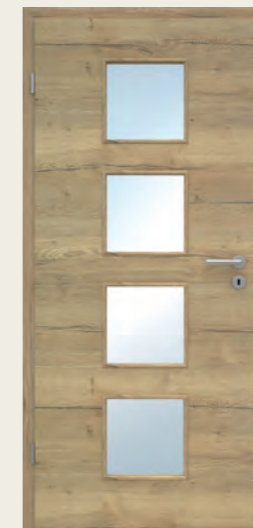

LA 004

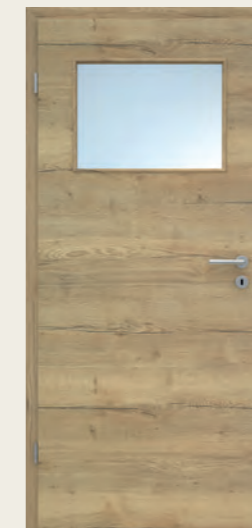

LA 005

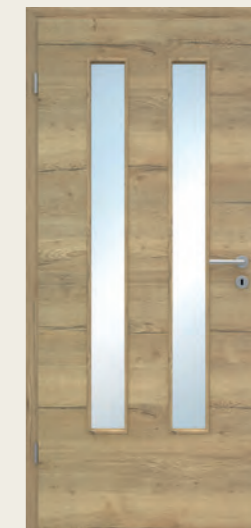

LA 006



LA 008 B



LA 008 M

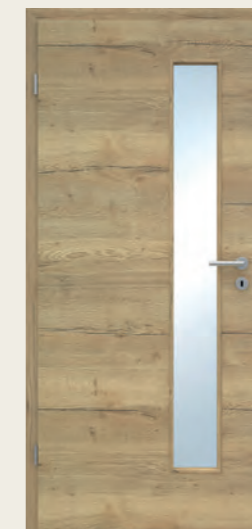

LA 008 S

GLATTE TÜREN
CPL MATTLINE

DESIGNOBERFLÄCHEN



Brillantweiß

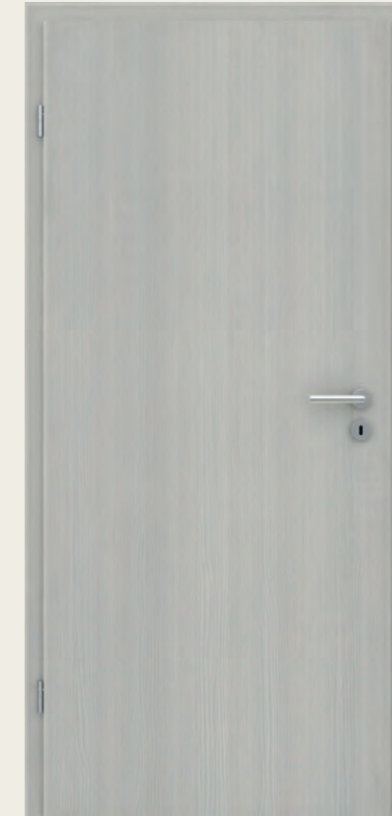

Lichtgrau



Mineralgrau



Brillantweiß quer

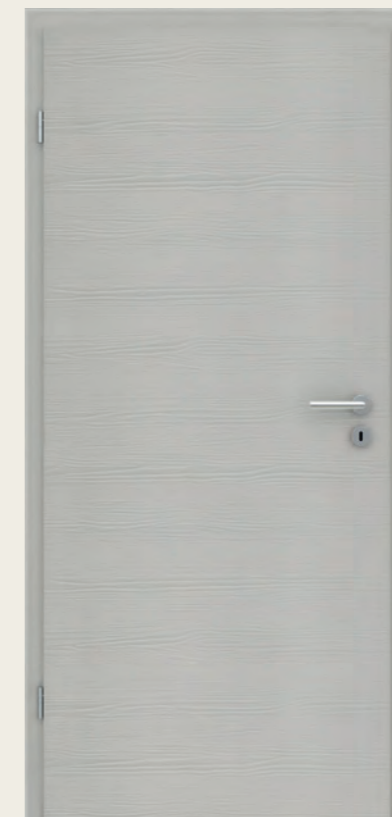

Lichtgrau quer



Mineralgrau quer



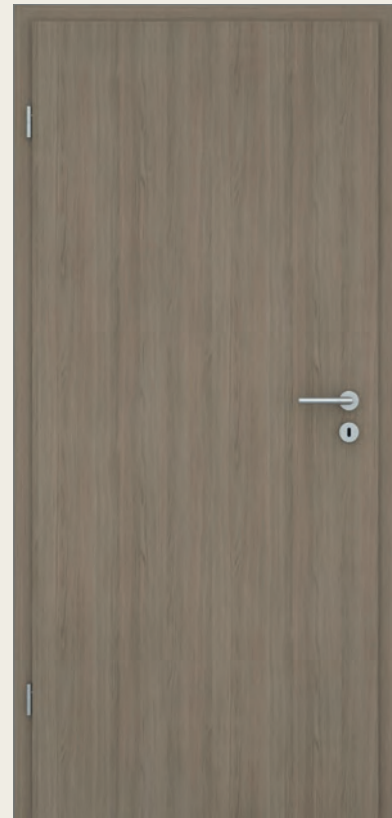

Eiche Platingrau

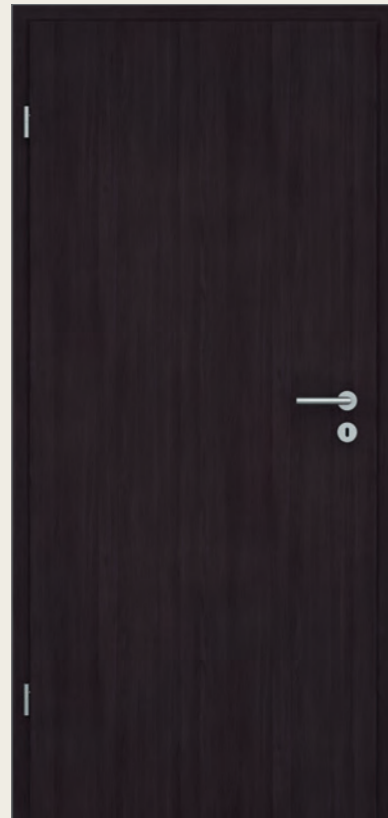

Eiche Graphitrau

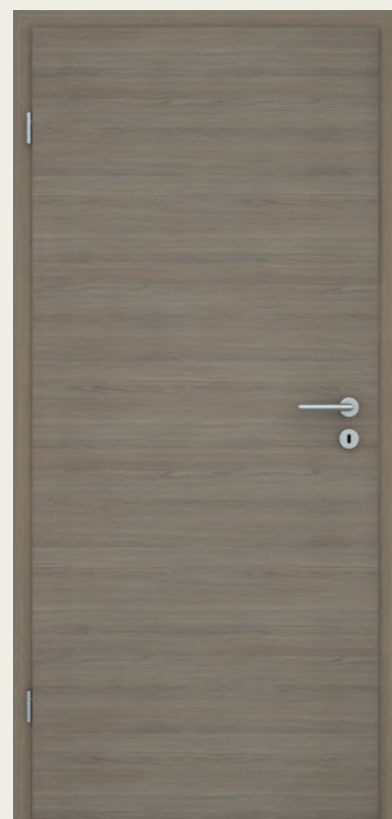

Eiche Platingrau quer

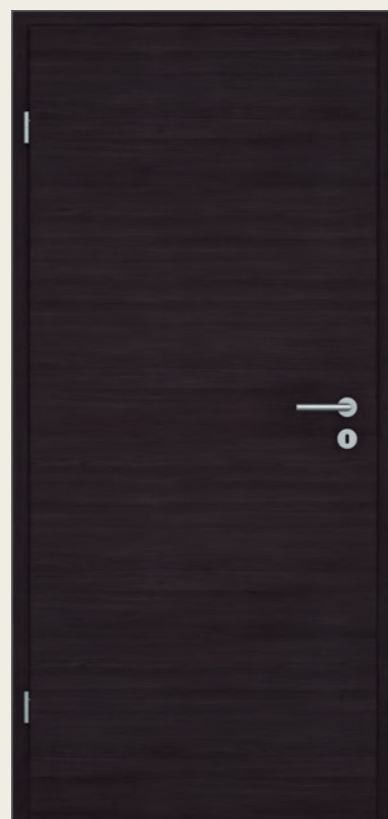

Eiche Graphitrau quer

VARIANTEN MIT GLAS



LA XL

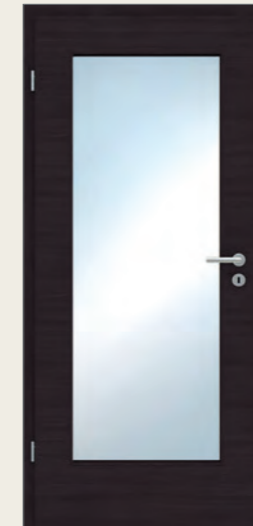

LA 001



LA DIN

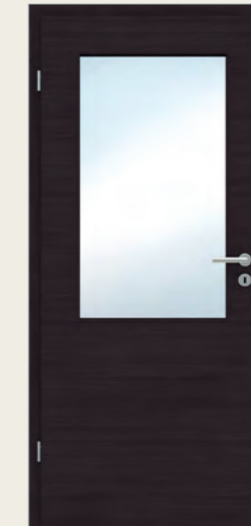

LA 002



LA 003

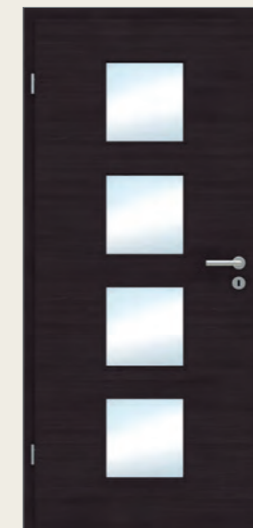

LA 004

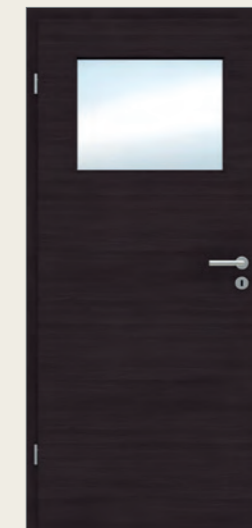

LA 005



LA 006



LA 008 B



LA 008 M

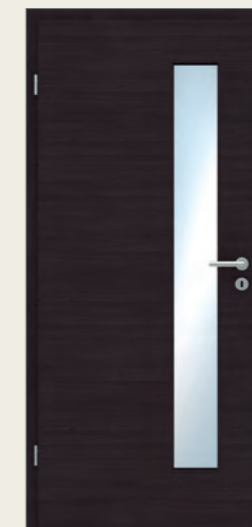

LA 008 S

GLATTE TÜREN
CPL COLOUR

DESIGNOBERFLÄCHEN



Onyxgrau



Uni weiß



Uni grau



Arktisgrau

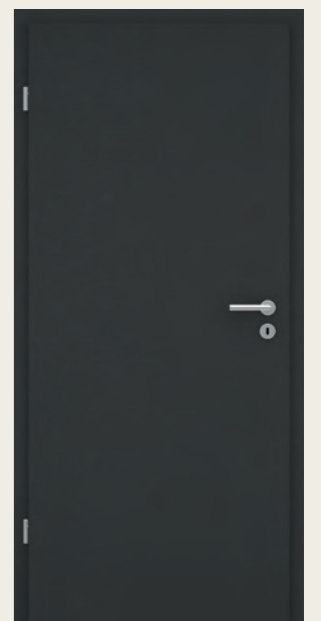

Anthrazitgrau

VARIANTEN MIT GLAS



LA XL LA 001 LA DIN LA 002 LA 003 LA 004 LA 005 LA 006 LA 008 B LA 008 M LA 008 S



CPL



Pergamentstruktur



Designkante



Röhrenspannern



ECHTHOLZ

Holz steht seit jeher für natürliches und gesundes Wohnen – weil eben jeder Baum 100% natürlich und einmalig ist. Jedes Furnier oder Vollholz ist daher ein Unikat in seiner Farbe, Maserung sowie Struktur und verleiht auch Türen so eine individuelle Note.

Unsere Echtholz-Kollektion beinhaltet eine erlesene Auswahl an Furnier- und Vollholztüren mit unterschiedlichen Strukturen und Farbgebungen. Neben bekannten Klassikern wie Ahorn und Buche überzeugt beispielsweise astiges Eiche-Furnier mit einem modernen und markanten Erscheinungsbild oder Finline-Furnier mit einer schlichten und ruhigen Maserung – beides zeitgemäß auch mit matter Oberfläche. Als Landhausklassiker in Kassettenform runden Vollholztüren in Kiefer und Fichte das Sortiment mit vielen Modellvarianten ab.

GLATTE TÜREN FURNIER KLASSIK

ECHTHOLZ



VARIANTEN MIT GLAS

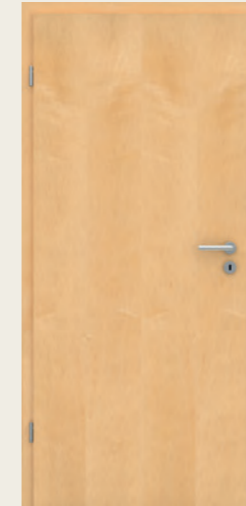

Ahorn

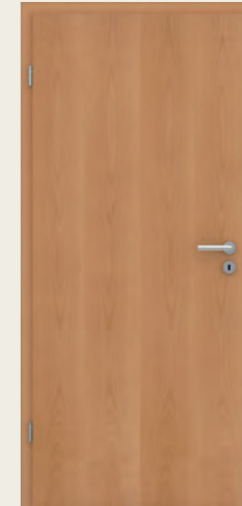

Buche

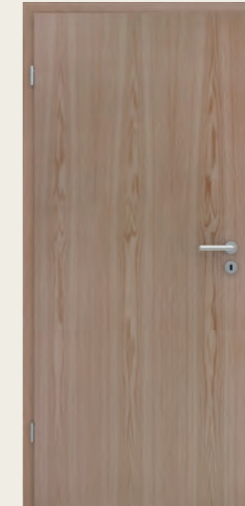

Eiche Hell



LA XL

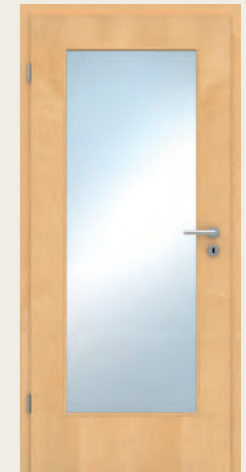

LA 001

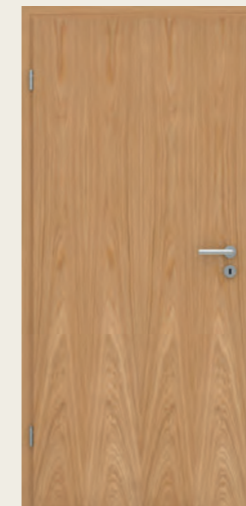

Eiche Natur



Eiche Rustikal

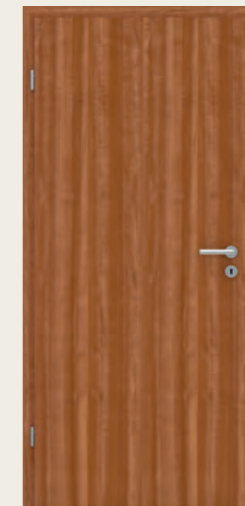

Macore



LA DIN



LA 002



LA 003

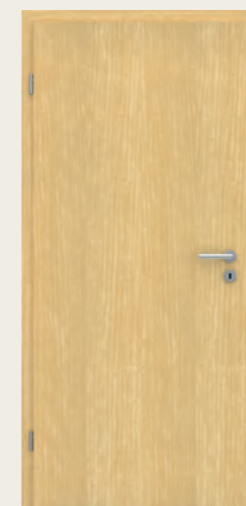

Limba

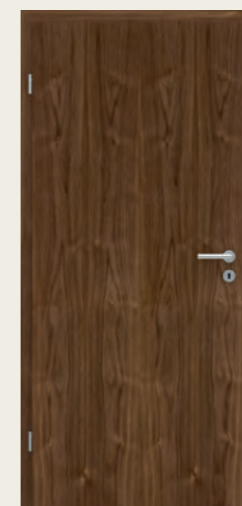

Amerikanisch Nussbaum



Mahagoni



LA 004



LA 005



LA 006



LA 008 B



LA 008 M



LA 008 S



Furnier



Naturlackierung



Eckkante



Röhrenspankern

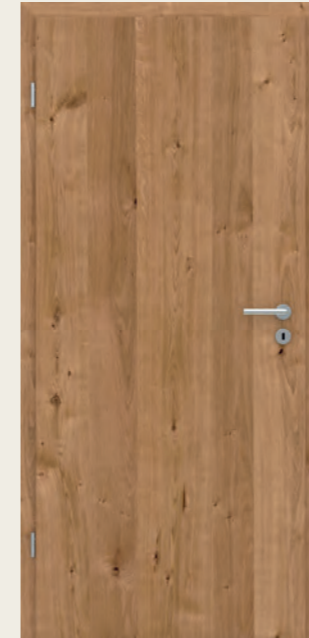

Natur

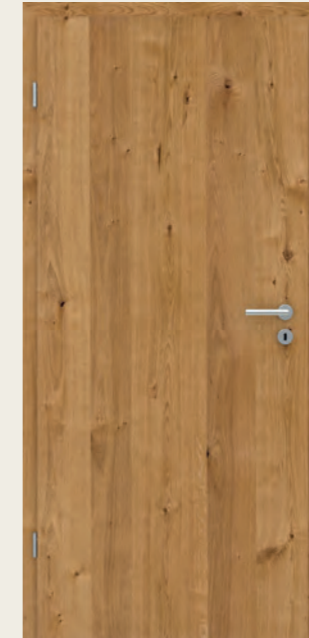

Natur geölt

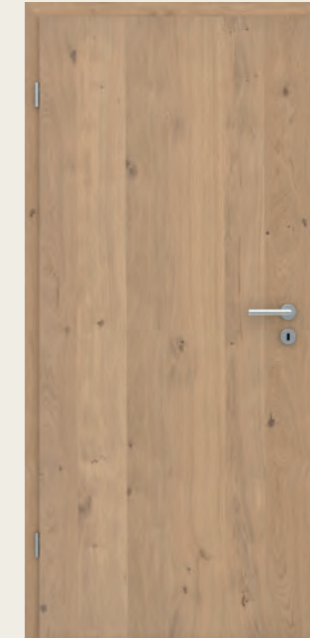

Creme



Bronze

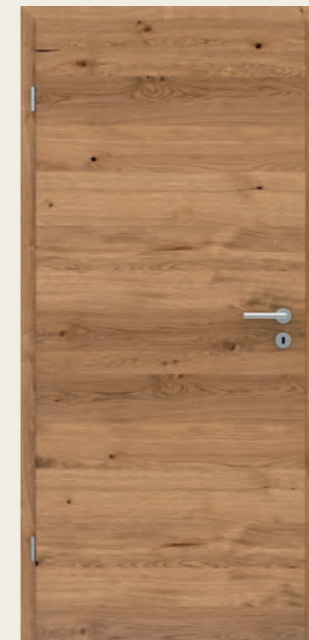

Natur quer

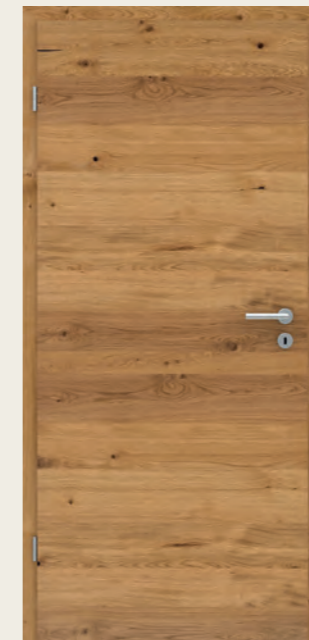

Natur geölt quer

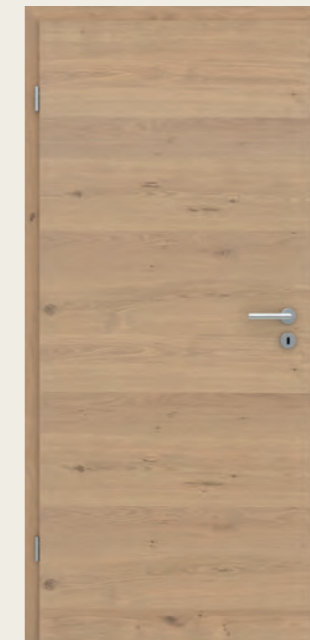

Creme quer

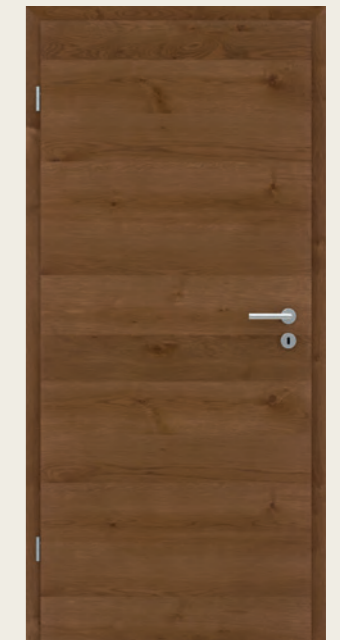

Bronze quer

VARIANTEN MIT GLAS



LA XL

LA 001

LA DIN

LA 002

LA 003

LA 004

LA 005

LA 006

LA 008 B

LA 008 M

LA 008 S

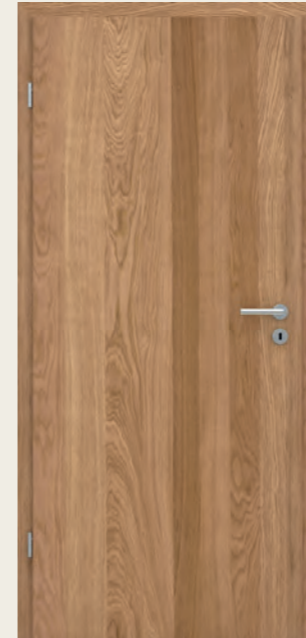

Natur

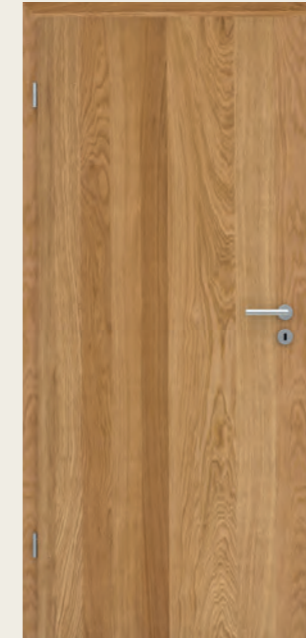

Natur geölt

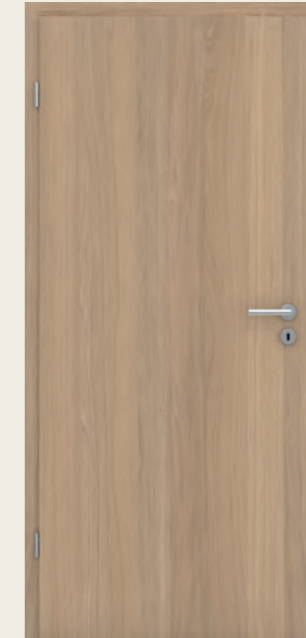

Creme

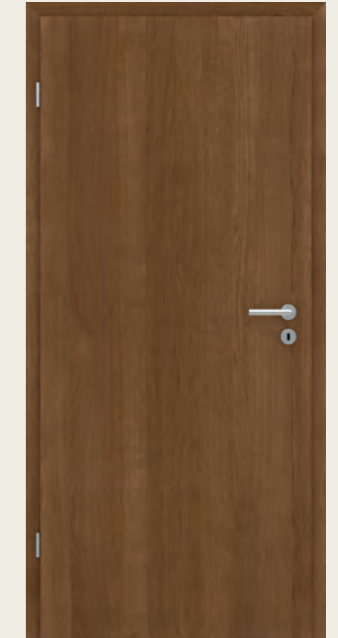

Bronze

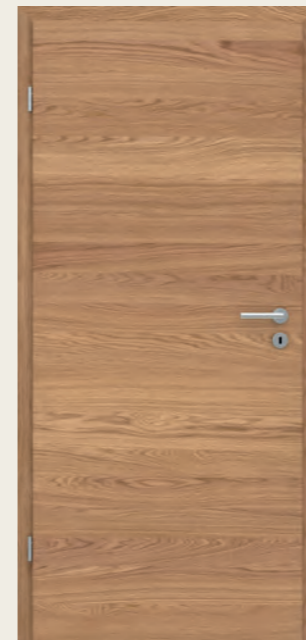

Natur quer

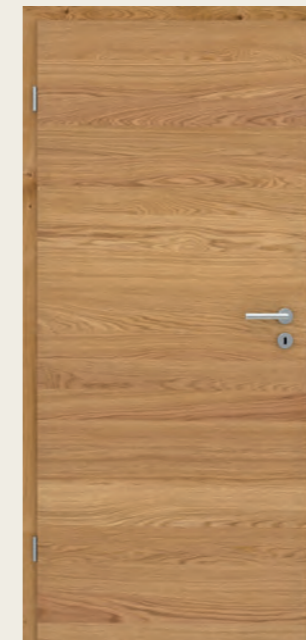

Natur geölt quer

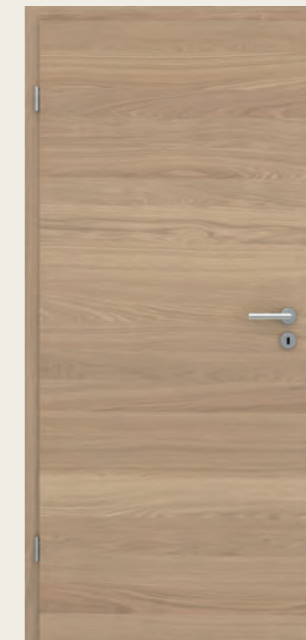

Creme quer

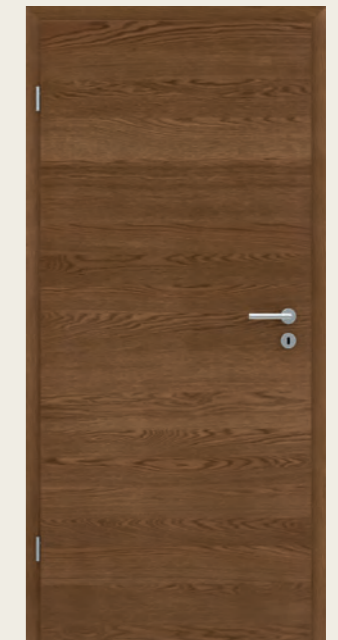

Bronze quer

VARIANTEN MIT GLAS



LA XL



LA 001



LA DIN



LA 002



LA 003



LA 004



LA 005



LA 006



LA 008 B



LA 008 M



LA 008 S



GLATTE TÜREN
FURNIER FINELINE
 ECHTHOLZ



Grey Darkgrey Beige Caramel Tabacco



Grey quer Darkgrey quer Beige quer Caramel quer Tabacco quer

VARIANTEN MIT GLAS



LA XL LA 001 LA DIN LA 002 LA 003 LA 004 LA 005 LA 006 LA 008 B LA 008 M LA 008 S



LISENEN

Hochwertige Metallveredelungen in Edelstahloptik, Chrom, Gold oder Schwarz setzen Akzente – besonders bei Türen. Ob horizontal oder vertikal verlaufend, flächenbündig oder aufliegend, dezente Lisenen bieten eine Vielzahl von Designmöglichkeiten. So verleihen sie jeder Tür ihren eigenen Charme.

Eine breite Auswahl an Türoberflächen, angefangen von Weiß bis hin zu verschiedenen Unifarben und Holzdesigns, bietet dazu die optimale Abstimmung mit dem jeweiligen Wohnraum. Türen mit Lisenen sind nicht nur robust und pflegeleicht, sondern erfüllen auch viele individuelle Ansprüche beim Einrichten und Wohnen.

LISENEN-VARIANTEN

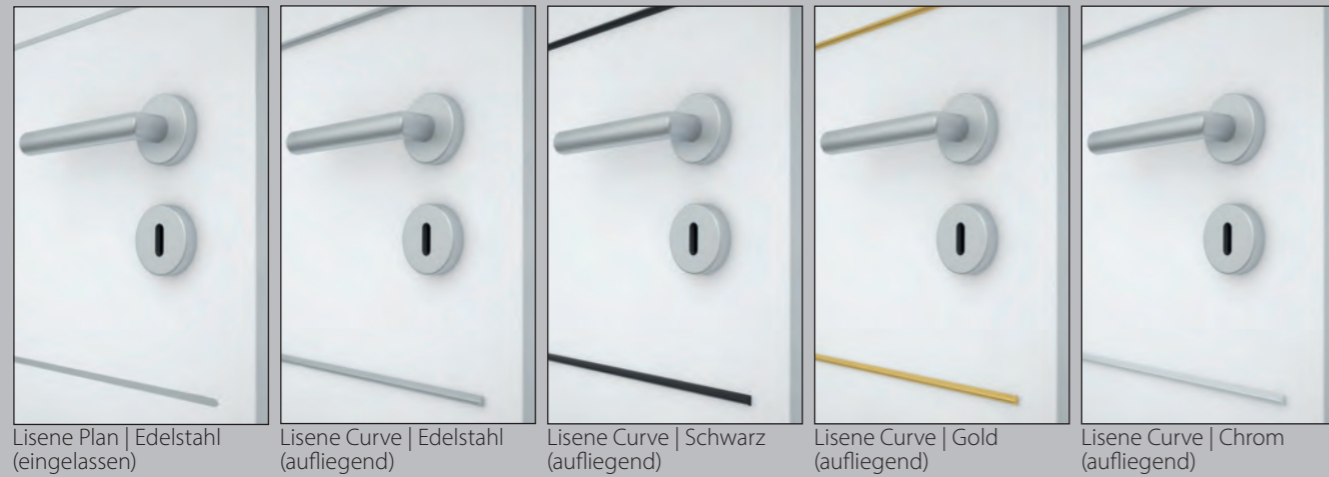

MODELL-VARIANTEN



VERFÜGBAR FÜR GLATTE TÜREN

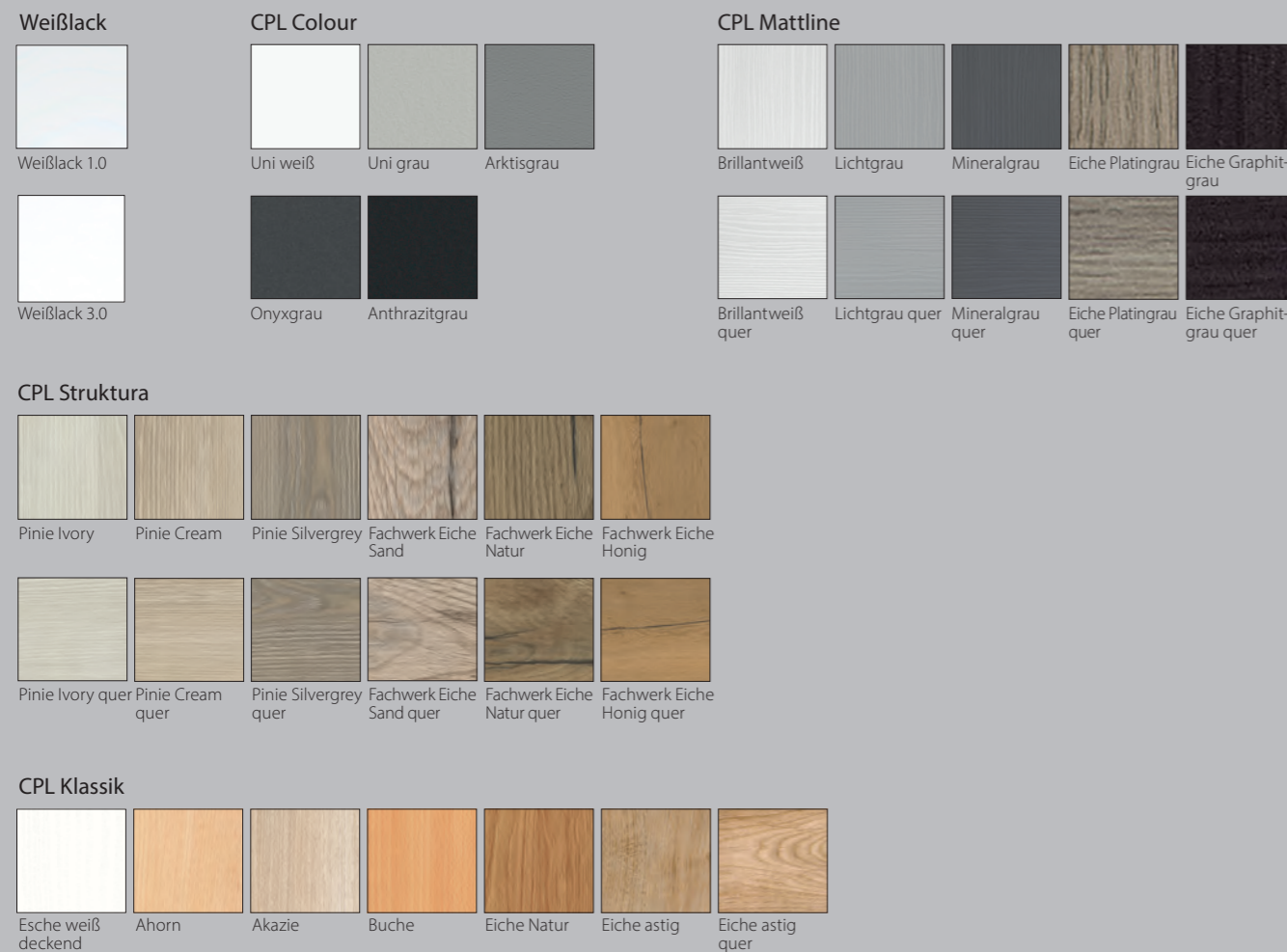

VARIANTEN MIT GLAS





STUMPF- EINSCHLAGEND

Etwas anders und noch moderner sind stumpfeinschlagende Wohnraumtüren – sie werden auch als flächenbündige Türen bezeichnet. Diese Bauform zeichnet sich dadurch aus, dass das Türblatt mit der Zarge eine einheitliche Fläche bildet. Verglichen mit gefalzten Türen gibt es bei stumpfeinschlagenden Türen keinen Absatz (Falz) und die Türbänder sind verdeckt im Türblatt eingelassen. Die Verschmelzung der Tür mit der Zarge und die Reduktion der sonst sichtbaren Scharniere erzeugt eine besondere Eleganz und minimalistische Optik im Wohnraum.

Eine Vielzahl von modernen und zeitlosen Türoberflächen und -formen steht auch für stumpfeinschlagende Türen zur Auswahl – passend zu fast allen Wohnstilen.

DESIGNTÜREN

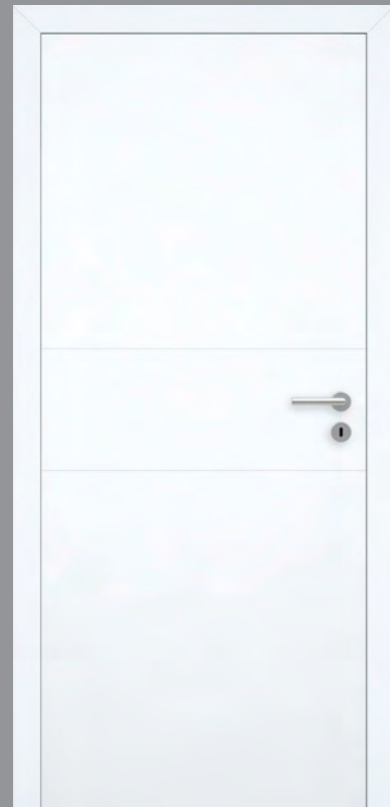

Verona VO3

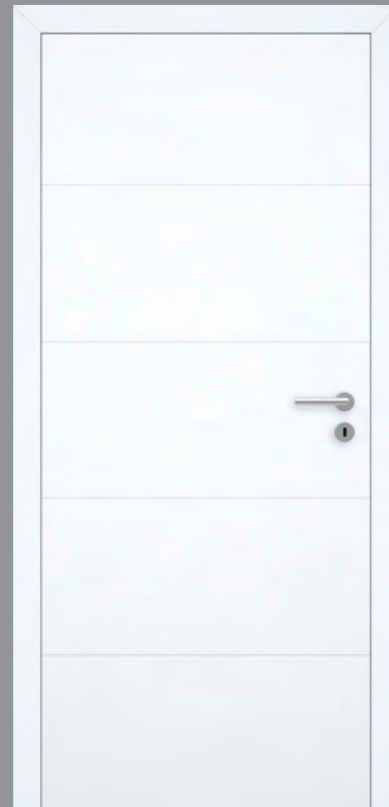

Verona VO5

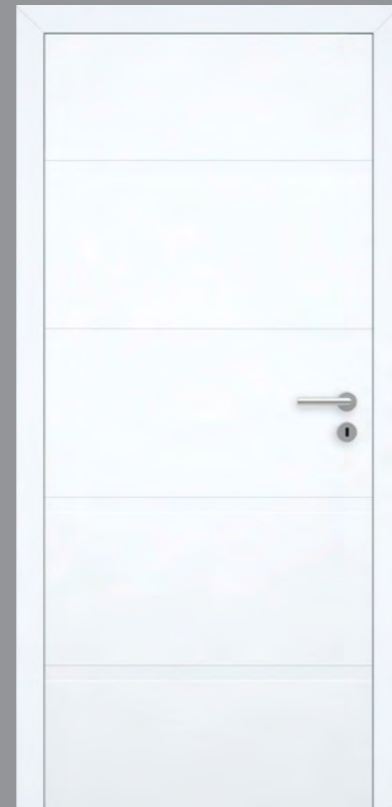

Modena MO5

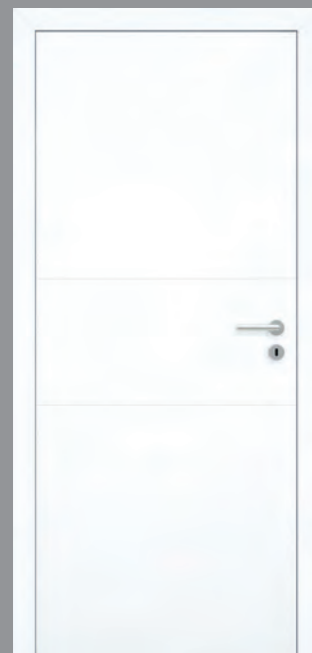

Genua GA3



Genua GA4

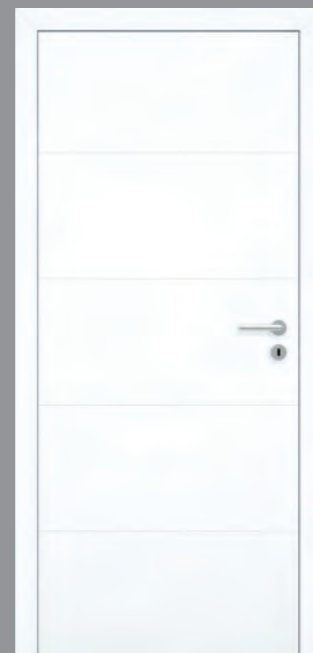

Genua GA5



Genua GA6

MÖGLICH FÜR ALLE GLATTEN TÜREN

Weißlack



Weißlack 1.0 Weißlack 3.0

CPL Colour



Uni weiß Uni grau Arktisgrau Onyxgrau Anthrazitgrau

CPL Klassik



Esche weiß deckend Ahorn Buche Akazie Eiche Natur Eiche astig Eiche astig quer

CPL Struktura



Pinie Ivory Pinie Cream Pinie Silvergrey Fachwerk Eiche Sand Fachwerk Eiche Natur Fachwerk Eiche Honig

CPL Mattline

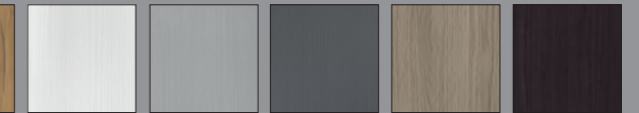

Brillantweiß Lichtgrau Mineralgrau Eiche Platin-grau Eiche Graphit-grau



Pinie Ivory quer Pinie Cream quer Pinie Silvergrey quer Fachwerk Eiche Sand quer Fachwerk Eiche Natur quer Fachwerk Eiche Honig quer Brillantweiß quer Lichtgrau quer Mineralgrau quer Eiche Platin-grau quer Eiche Graphit-grau quer

Furnier Klassik



Ahorn Buche Eiche Natur Eiche hell Eiche rustikal Macore Limba Amerik Nussbaum Mahagoni

Furnier Asteiche



Natur Natur geölt Creme Bronze



Natur quer Natur geölt quer Creme quer Bronze quer

Furnier Plankeneiche



Natur Natur geölt Creme Bronze



Natur quer Natur geölt quer Creme quer Bronze quer

Furnier Finline



Grey Grey quer Darkgrey Darkgrey quer Beige Beige quer Caramel Caramel quer Tabacco Tabacco quer



GLAS

Eine glasklare Entscheidung für viel Licht und Harmonie im Zuhause. Unsere Glastüren bringen nicht nur viel Helligkeit in Räume und trennen sie voneinander, sie sind gleichzeitig dekorative Einzelemente und schaffen dabei eine angenehme und offene Wohnatmosphäre. Ob als Ganzglastüren oder Türen mit Lichtausschnitten, Glas entfaltet seine strahlende Wirkung in jedem Wohnraum. Zudem sind Glastüren sehr pflegeleicht.

Das große Sortiment an Klar-, Matt-, Farb- und Strukturgläsern sowie Designmotiven bietet für jeden individuellen Geschmack und Anspruch eine passende Variante – von geradlinigen oder fantasiereichen Sandmotiven über effektvolle 3D-Motive und scharf gestochene Lasermotive bis hin zu brillanten Farbdrucken mit Hochglanzeffekt.

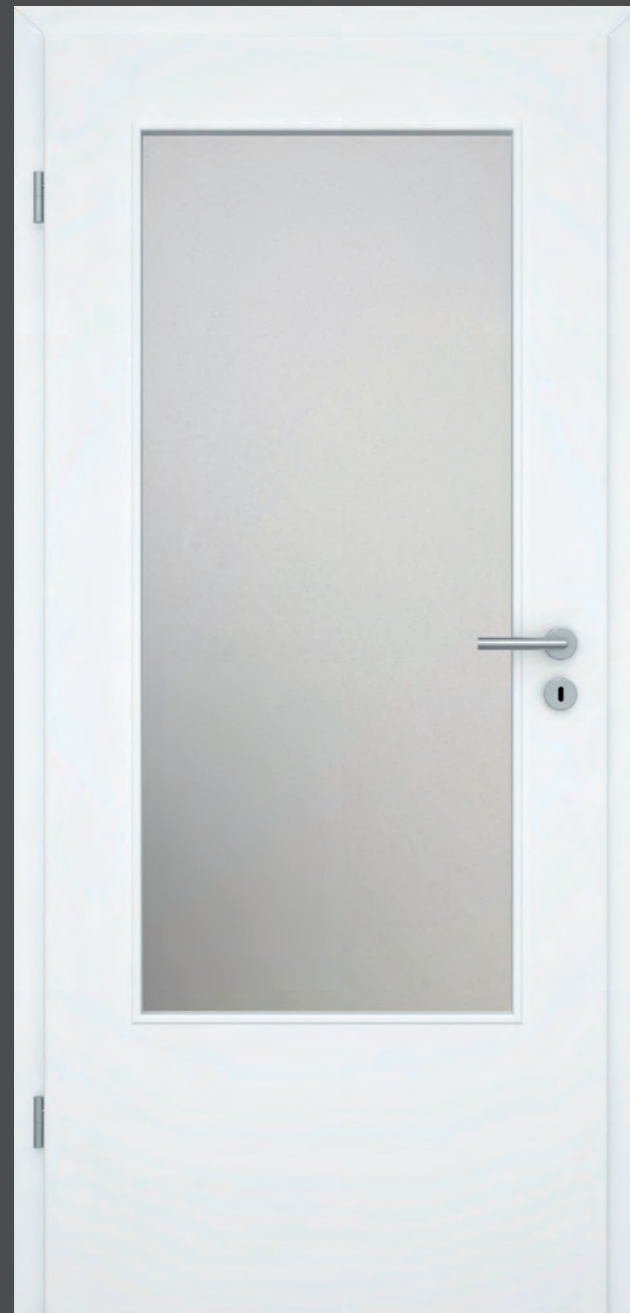

Verglasung Mattglas Satinato

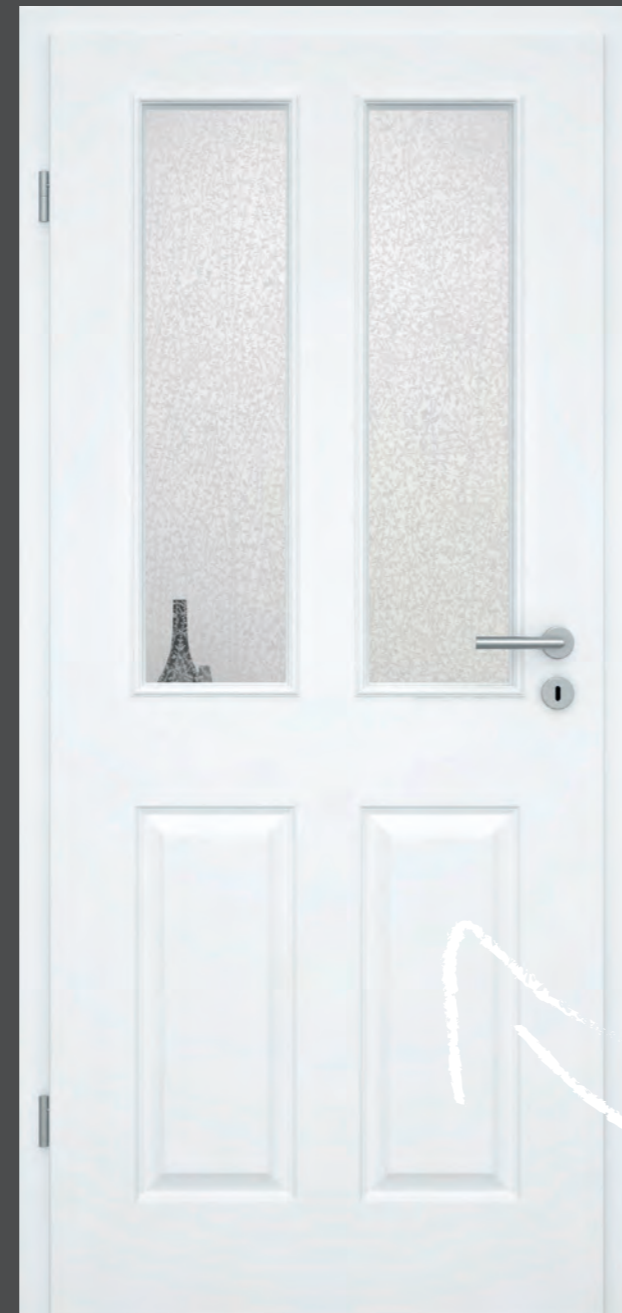

Verglasung Strukturglas Eisblume

AUSWAHL GLÄSER KLASSIK

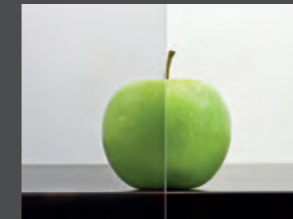

Float klar

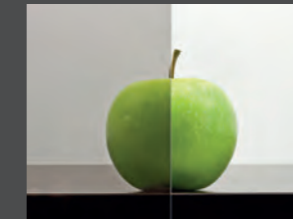

Parsol bronze

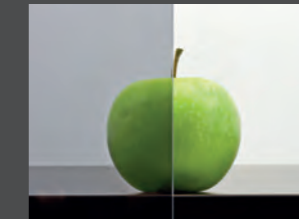

Parsol grau

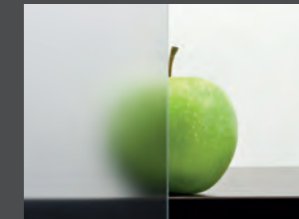

Satinato



Mattfolie hell

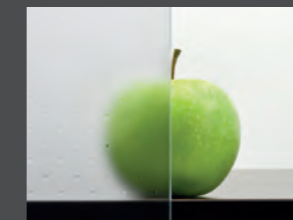

Pave

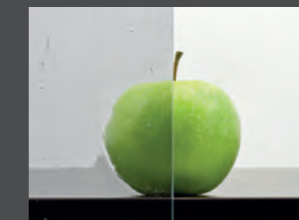

Altdeutsch K

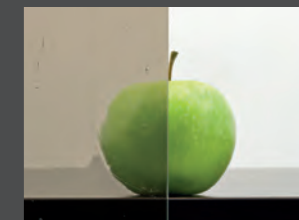

Altdeutsch K bronze



Barock

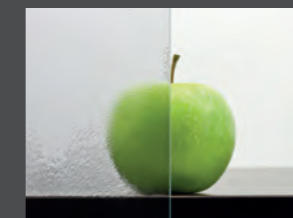

Chinchilla



Delta



Gothic



Silvit



Silvit bronze

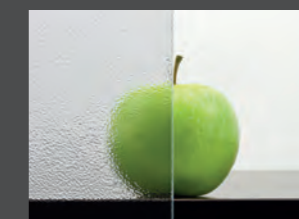

Ornament 504

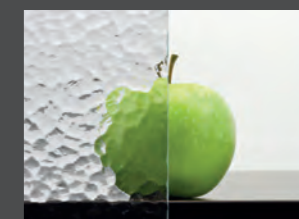

Ornament 528



Eisblume

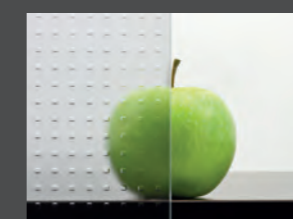

Mastercarre



Masterligne

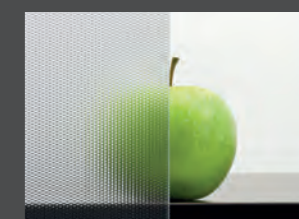

Masterpoint

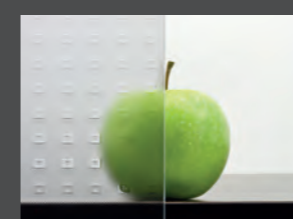

Royal King

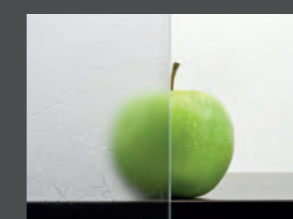

Uadi

Alle Lichtausschnitte des Türensoriments können für glatte Türen, Design- oder Stiltüren mit den unterschiedlichen Klassikgläsern kombiniert werden.

GROSSE LICHTAUSSCHNITTE MIT MOTIV-VERGLASUNG



Zum Beispiel:
Lichtausschnitt LA 001 mit Lasermotiv LS 10-N
Alle Lasermotive ab Seite 103!



Zum Beispiel:
Lichtausschnitt LA DIN Sandmotiv 3D SD 98
Alle Sandmotive 3D ab Seite 101!



Zum Beispiel:
Lichtausschnitt LA XL mit Sandmotiv SA 17-N
Alle Sandmotive ab Seite 91!

SPEZIELLE LICHTAUSSCHNITTE



Zum Beispiel:
Lichtausschnitt 2GLA mit Sandmotiv SA 202.

Für große Lichtausschnitte – LA DIN, LA 001 und LA XL bei glatten Türen sowie 1G LA bei Stiltüren – stehen Sand-, Laser-, und Sand 3D-Motive in vielen Designs zur Auswahl.

Für kleine und schmale Lichtausschnitte LA 002, LA 008, 2G LA, 4G LA und 4G 2LA stehen speziell angepasste Designmotive zur Auswahl.



MIT KLASSIK-VERGLASUNG



MIT MOTIV-VERGLASUNG



VERFÜGBARE OBERFLÄCHEN:



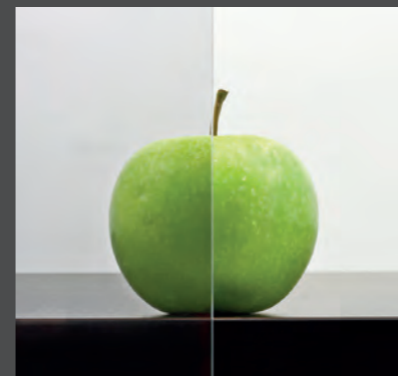

Klarglas

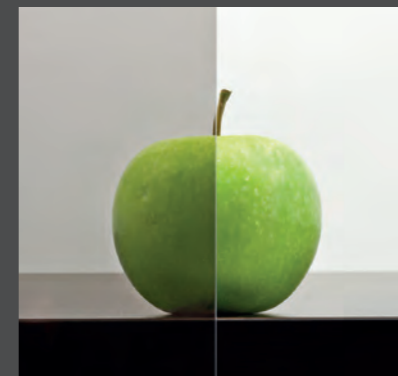

Parsol bronze

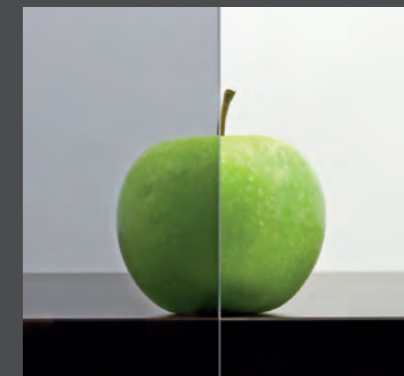

Parsol grau

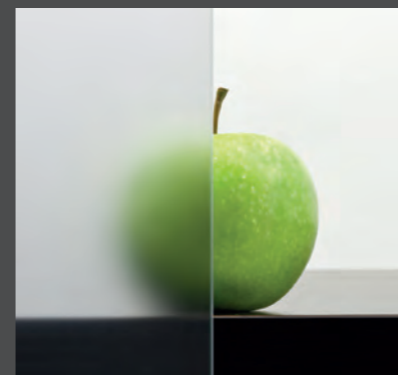

Satinato

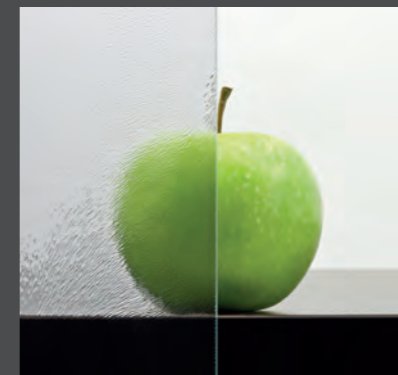

Chinchilla



Silvit

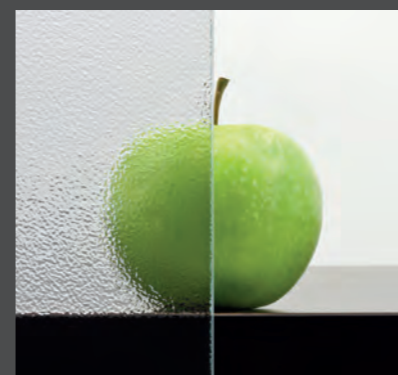

Ornament 504

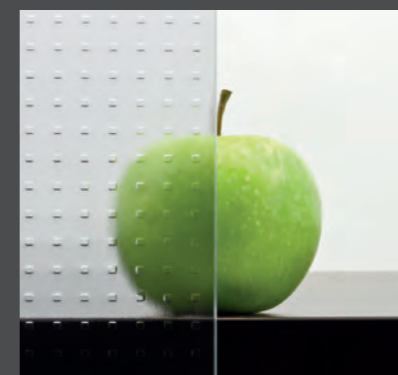

Mastercarre

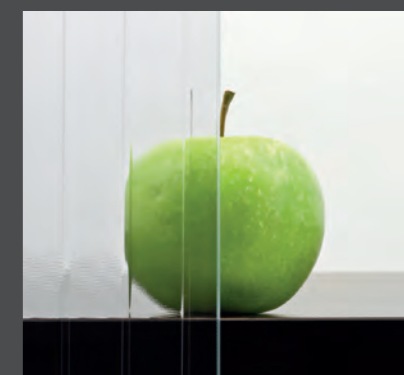

Masterligne



Masterpoint

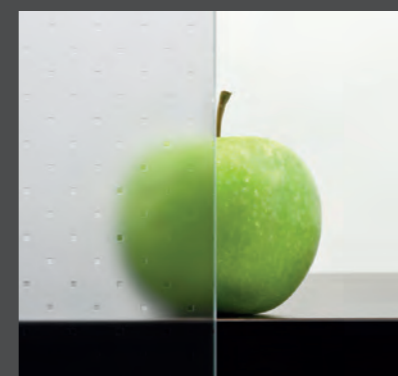

Pave

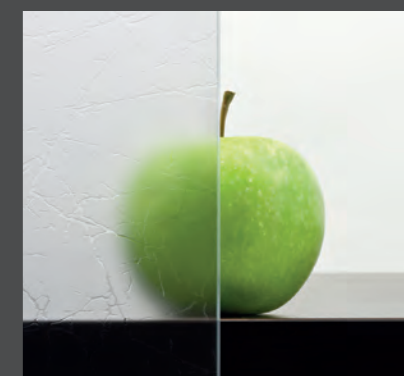

Uadi

GANZGLASTÜREN
SANDMOTIVE

GLAS



SA 18



SA 80

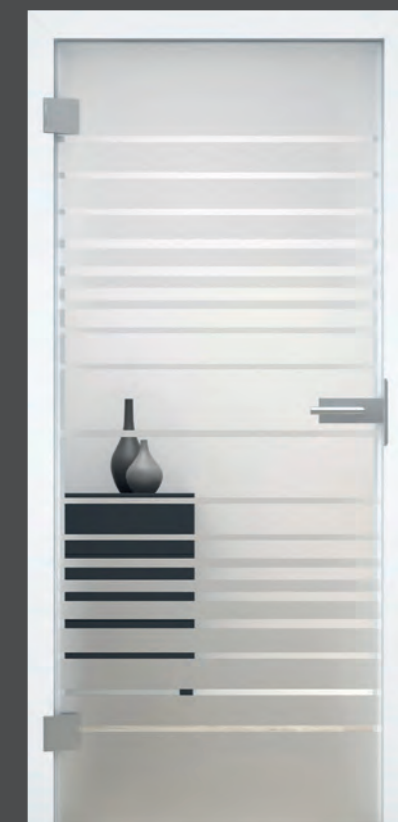

SA 17



SA 18-N

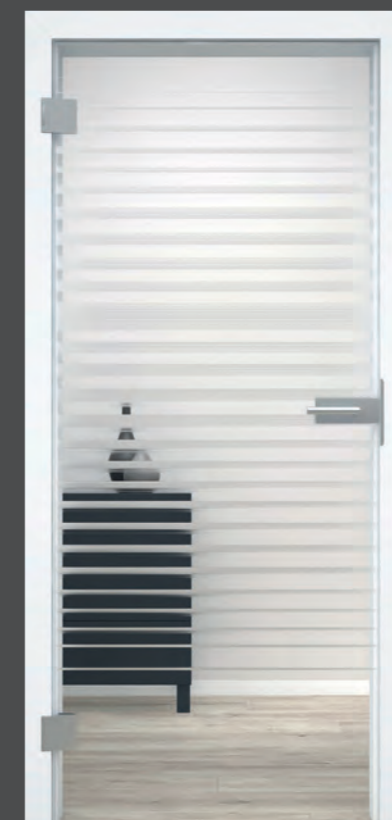

SA 80-N



SA 17-N



SA 21



SA 41



SA 48

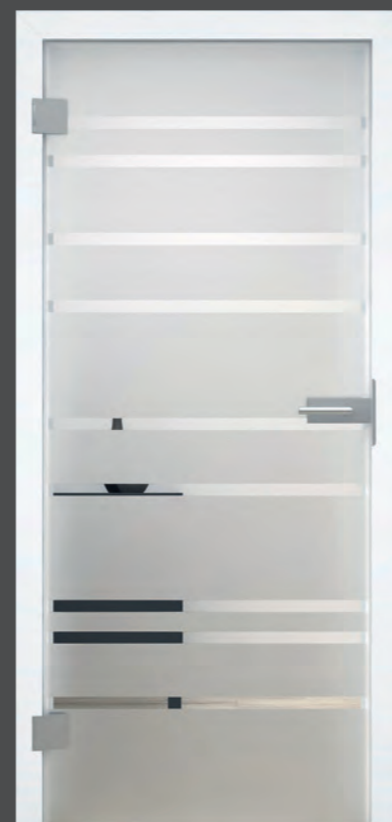

SA 89



SA 3



SA 96

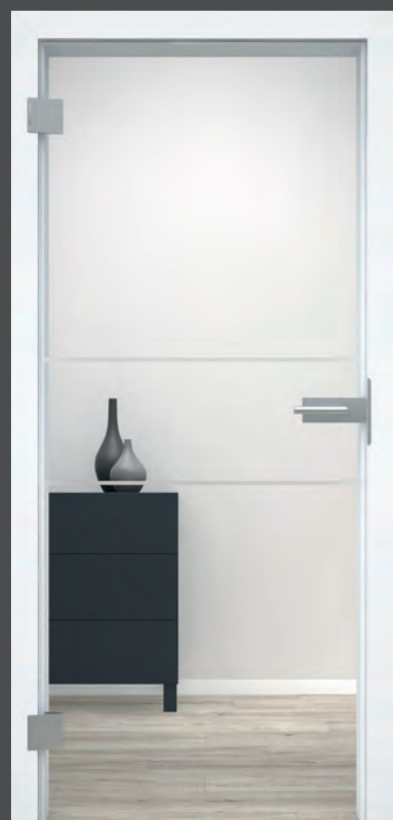

SA 21-N

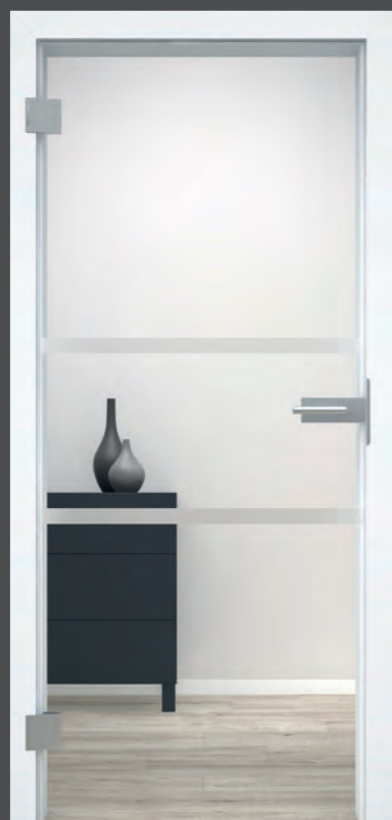

SA 41-N

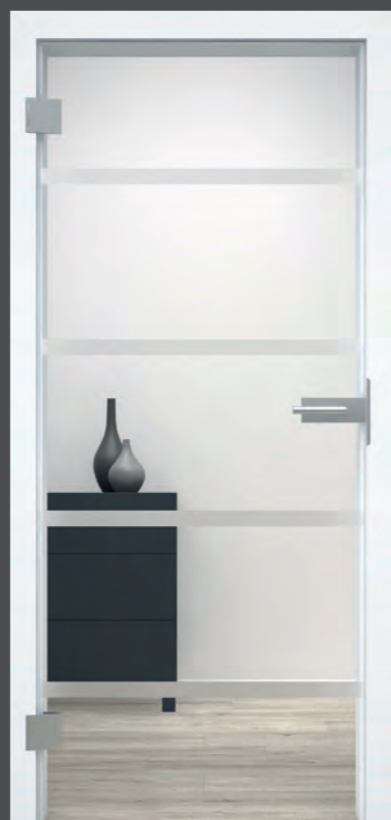

SA 48-N

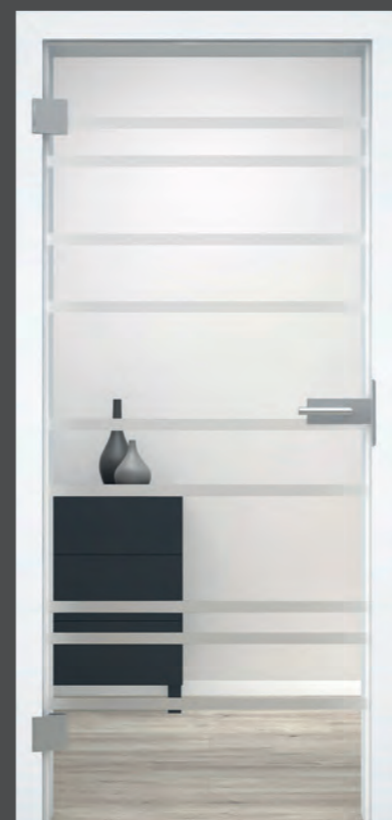

SA 89-N



SA 3-N



SA 96-N



SA 51



SA 86



SA 87



SA 95



SA 1



SA 36

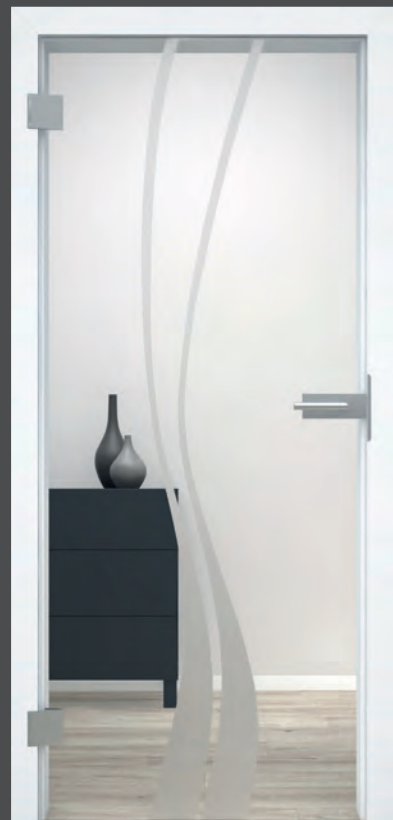

SA 51-N

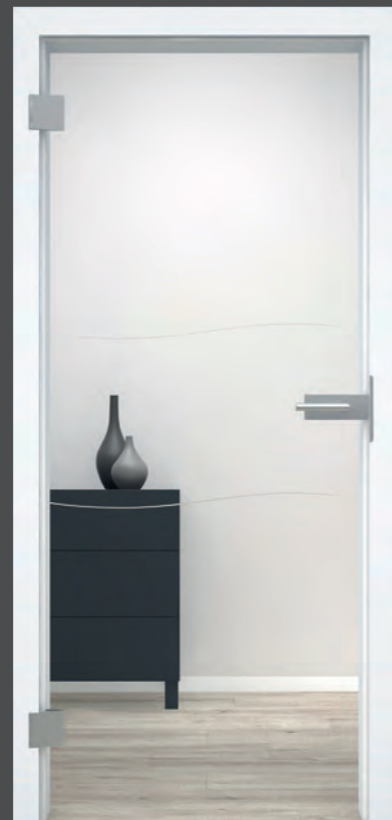

SA 86-N

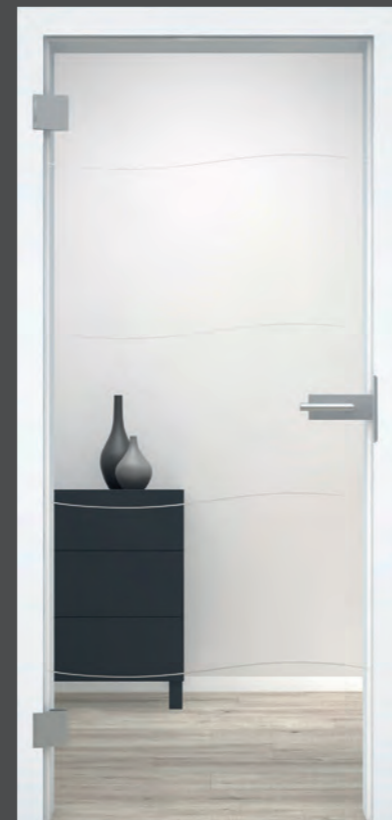

SA 87-N



SA 95-N

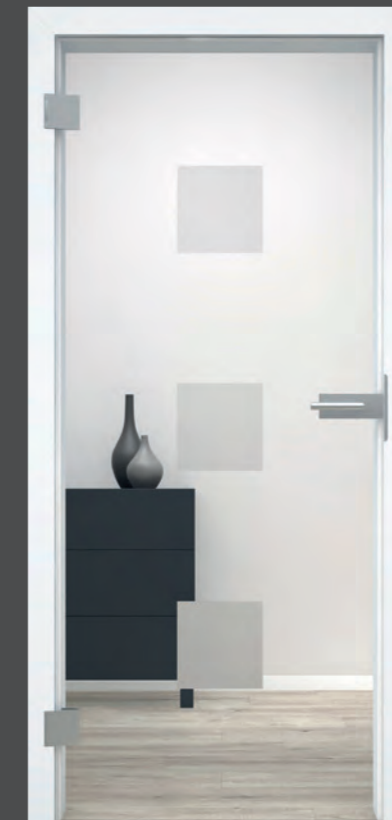

SA 1-N

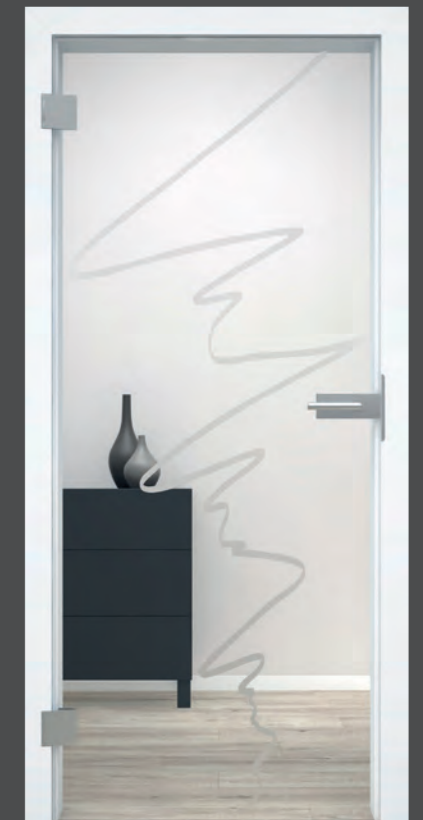

SA 36-N

GANZGLASTÜREN
SANDMOTIVE

GLAS



SA 90



SA 91



SA 38



SA 92



SA 52

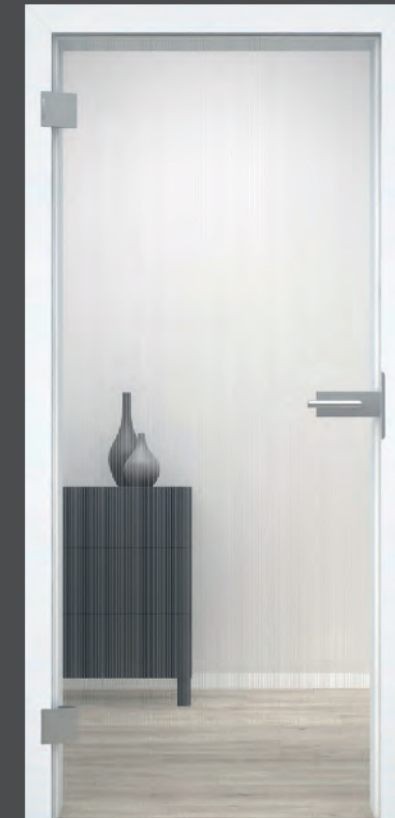

SA 93

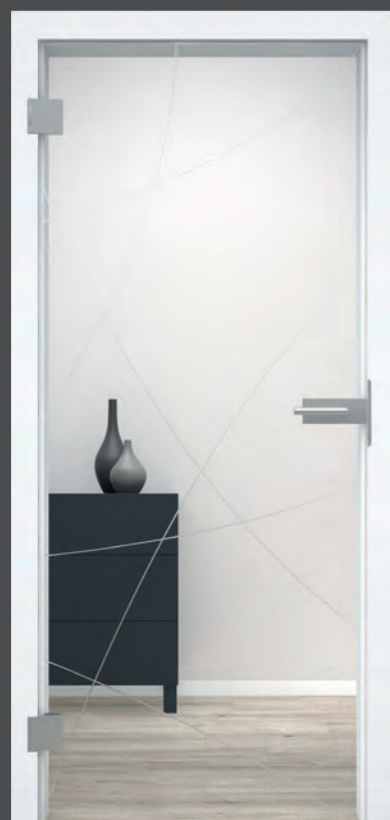

SA 90-N



SA 91-N



SA 38-N



SA 92-N



SA 52-N



SA 94

GANZGLASTÜREN
SANDMOTIVE

GLAS



Sand 54



Sand 54-N



Sand 58



Sand 58-N



Sand 76

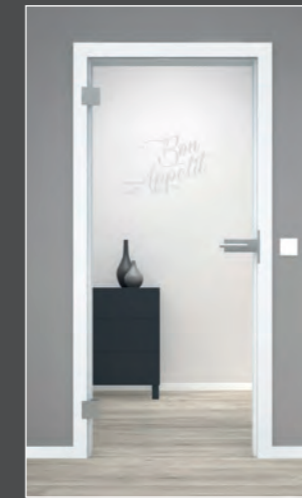

Sand 76-N



Sand 77



Sand 77-N



Sand 72

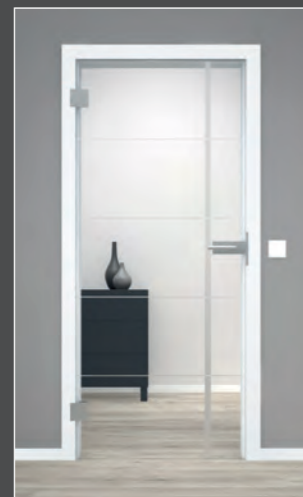

Sand 72-N



Sand 73



Sand 73-N



Sand 78



Sand 78-N



Sand 79



Sand 79-N



Sand 74



Sand 74-N



Sand 75

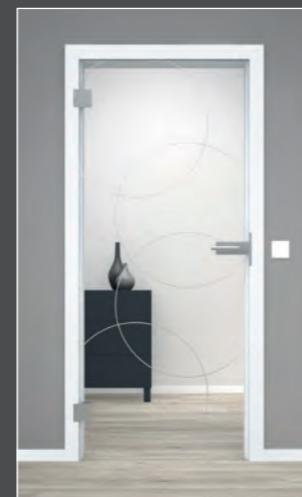

Sand 75-N



Sand 85

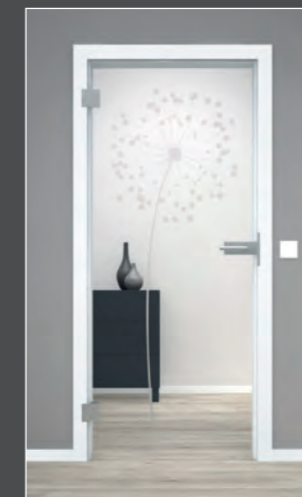

Sand 85-N



GANZGLASTÜREN
SANDMOTIVE 3D

GLAS



SD 11



SD 75



SD 97

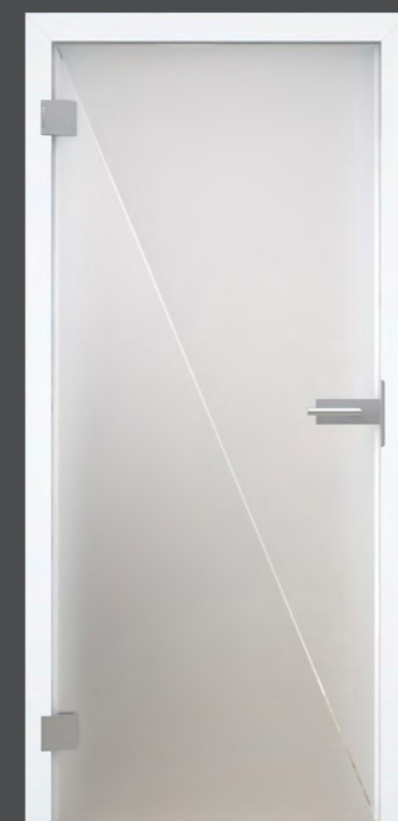

SD 98

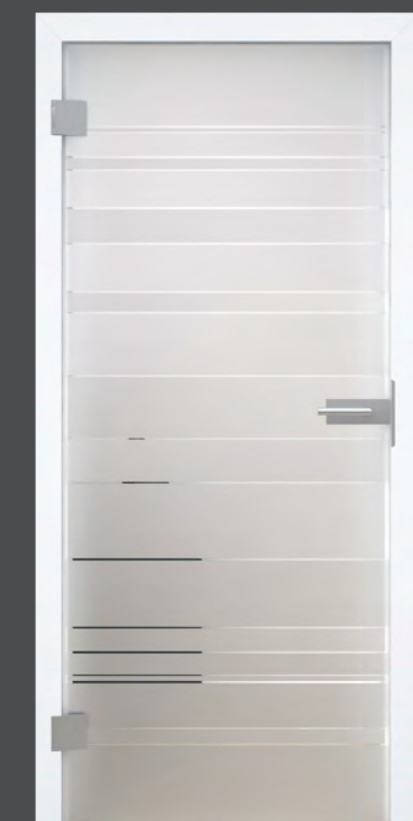

SD 99

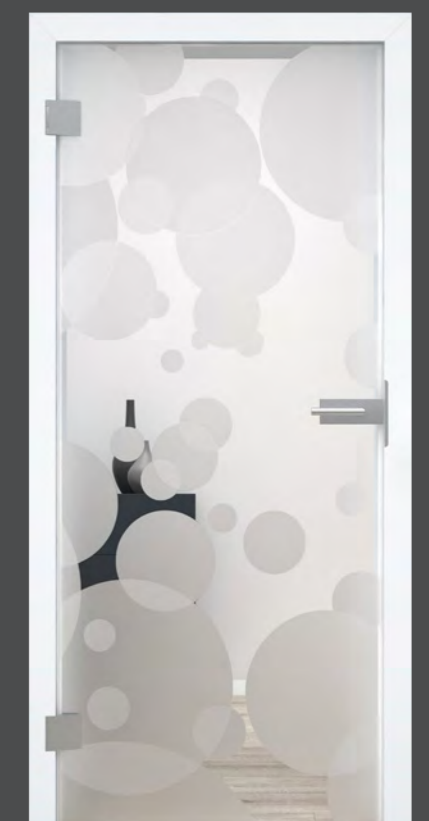

SD 100

GANZGLASTÜREN
LASERMOTIVE

GLAS

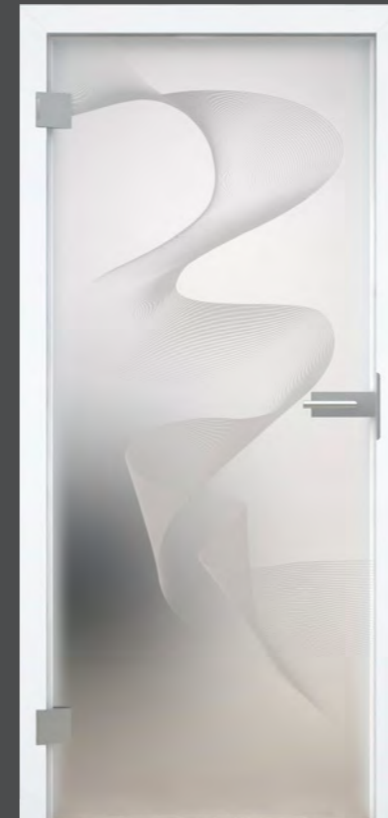

LS 10

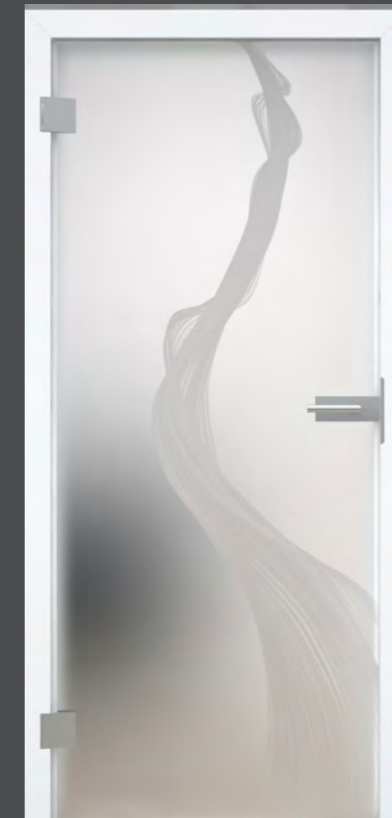

LS 12

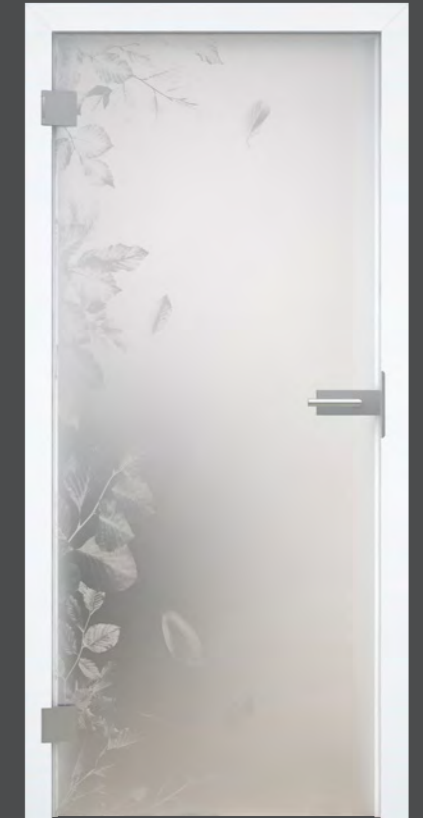

LS 22



LS 10-N

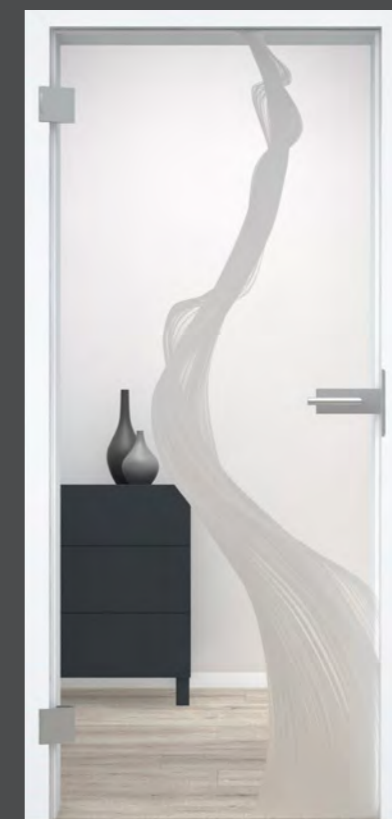

LS 12-N

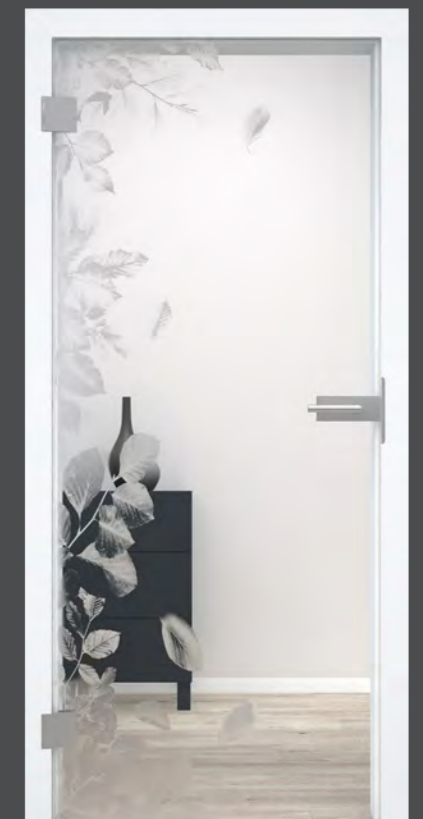

LS 22-N

GANZGLASTÜREN
LASERMOTIVE

GLAS



LS 23

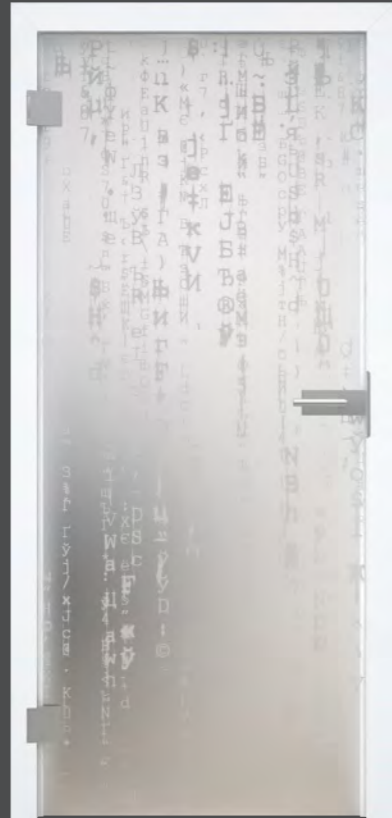

LS 24

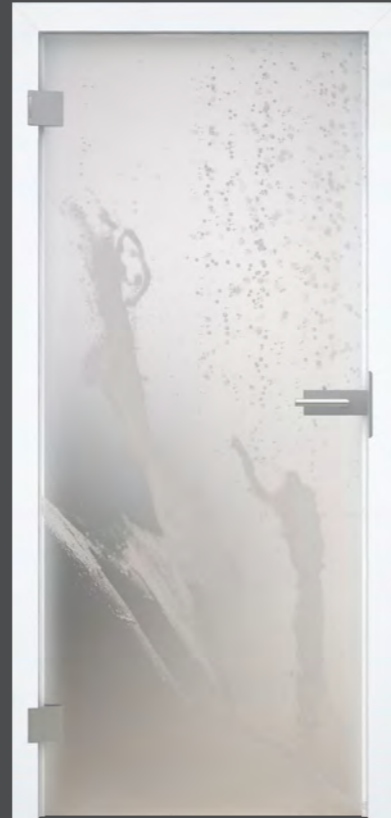

LS 25

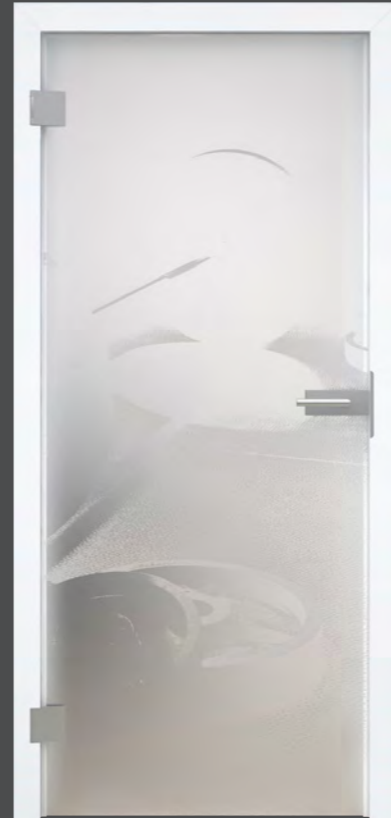

LS 26

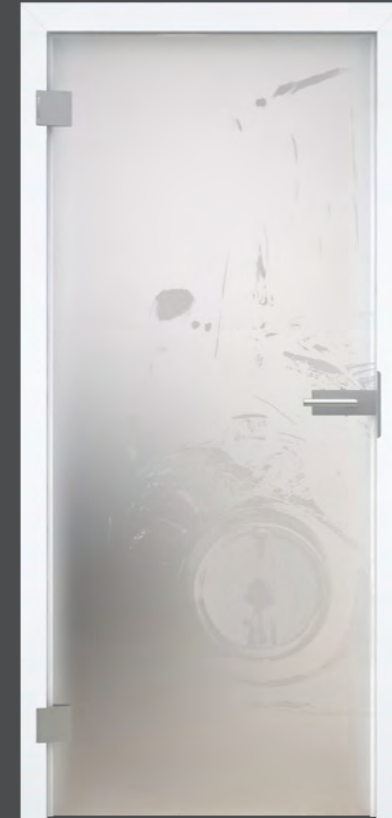

LS 27



LS 20



LS 23-N

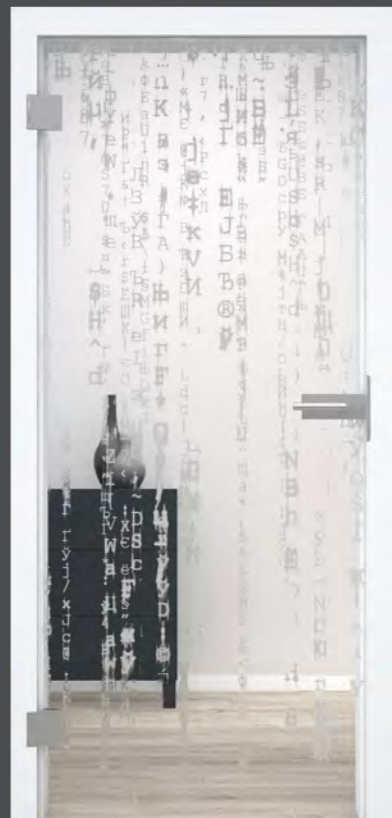

LS 24-N

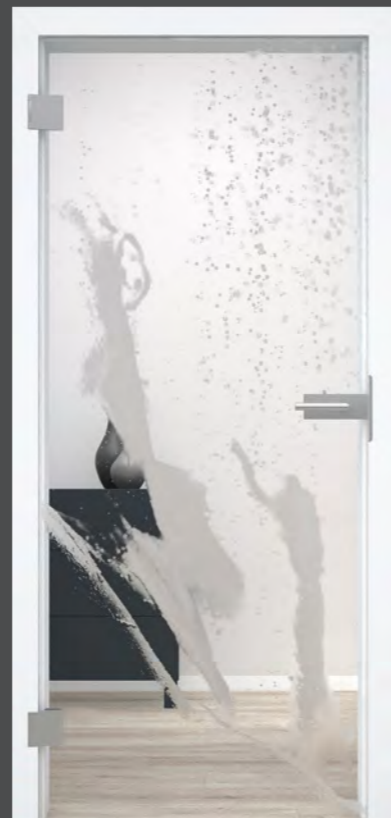

LS 25-N

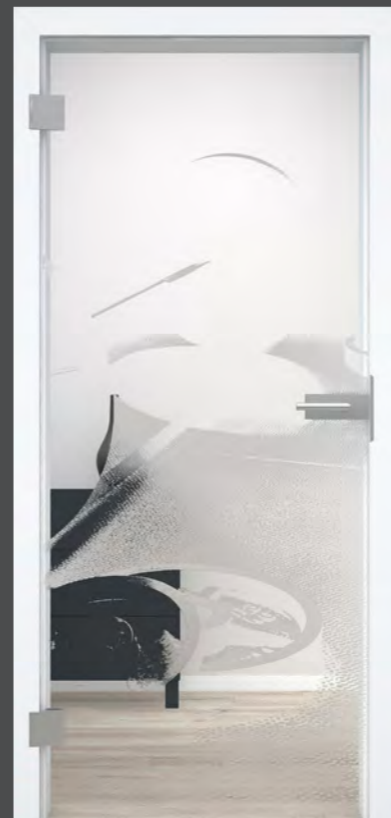

LS 26-N

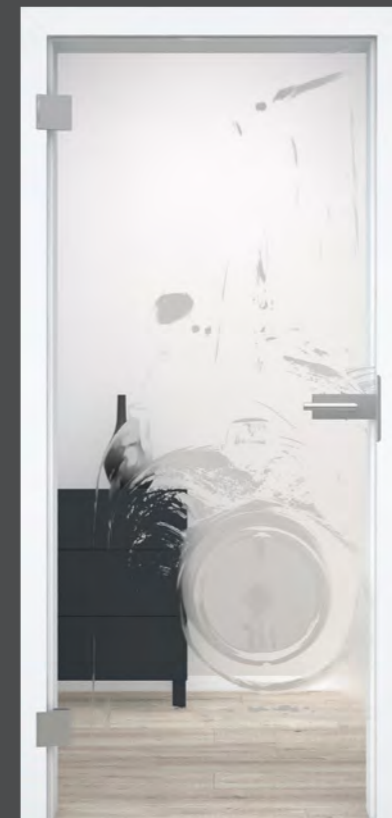

LS 27-N



LS 20-N

GANZGLASTÜREN
BLACKMOTIVE

GLAS

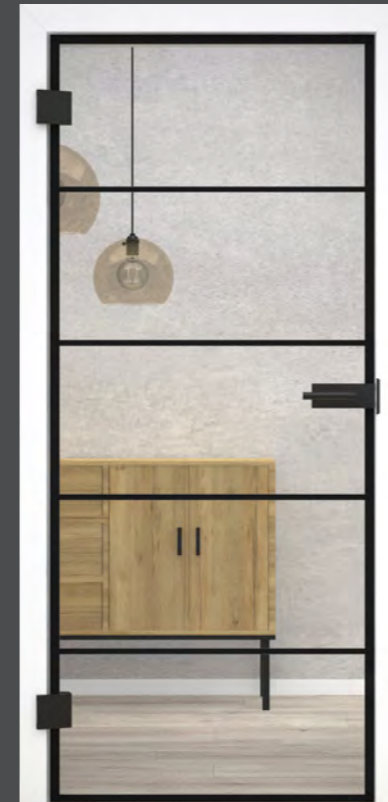

BK 1



BK 2



BK 3



BK 4

Schwarze Pulverbeschichtung auf klarem Glas – der Hingucker in jedem Wohnraum!
Das Besondere: Die schwarze Kante.



GANZGLASTÜREN
PRINTMOTIVE

GLAS



PT 10

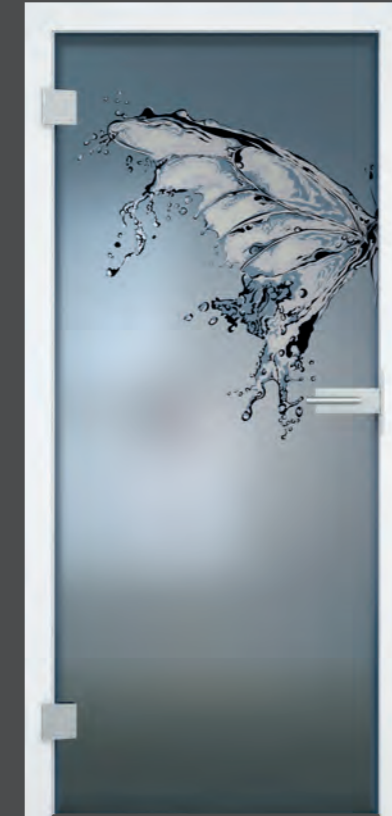

PT 13



PT 22

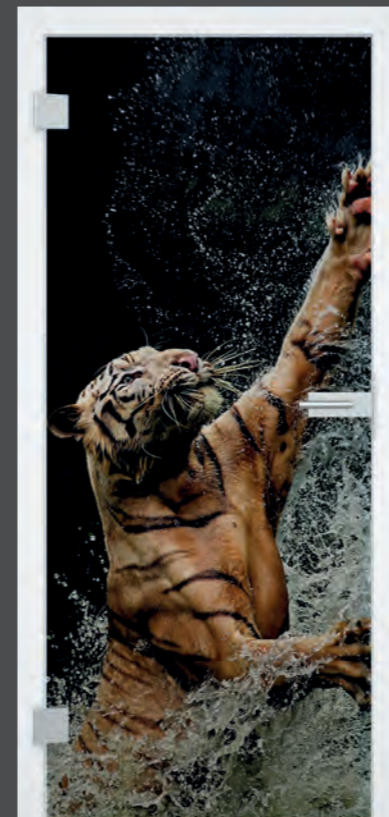

PT 23

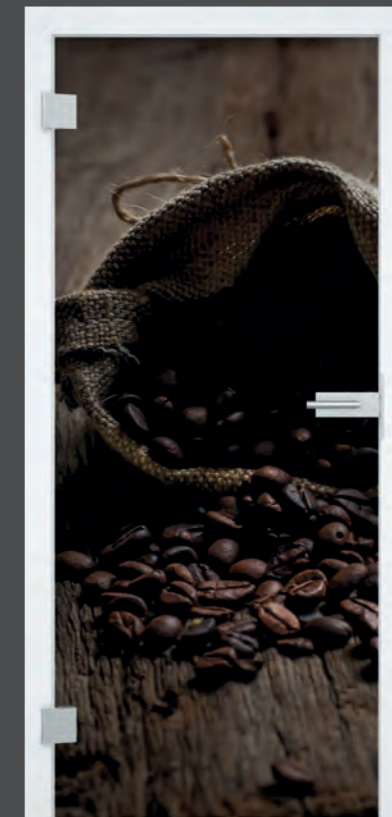

PT 24

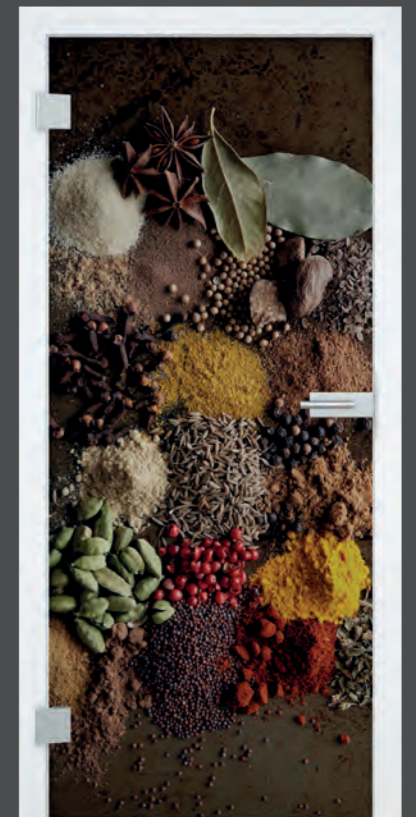

PT 25

SAND- & LASERMOTIVE
PARSOL GRAU

GLAS



New Inspiration!

Sand- und Lasermotive auf grauem
Parsol-Glas wirken einzigartig und setzen
moderne Akzente.



TÜRSYSTEME

Nicht nur ziehen und drücken – Wohnraumtüren können auch anders bewegt werden. Der Raumkomfort beginnt bei der Tür, dabei liegt der Fokus auf Flexibilität und Funktion. Unsere Türsysteme bieten dahingehend verschiedene Lösungskonzepte.

Schiebetürsysteme sind bewährte Klassiker, die im Laufe der Jahre in Design und Funktion immer weiter optimiert wurden. Ob Holzschiebetüren in passender Optik zur normalen Drehtür oder Glasschiebetüren als einzelne Raumhighlights, beide verbinden und trennen Räume auf eine besonders leichte und moderne Weise. Angeboten werden dazu verschiedene Laufschiene-Varianten für Wand- und Deckenmontage sowie ein- und zweiflügelige Ausführungen – angefangen von Systemen mit modernen Abdeckblenden bis hin zu Systemen mit offenem Designbeschlag. Dabei sind Schiebetüren aufgrund der kugelgelagerten Laufrollen und der optionalen Einzugsdämpfung nahezu lautlos.

Easy Go-Systeme bieten Funktion und Design pur. Sie sind eine neue Generation von Türbeschlägen für die Kombination mit Glastüren. Bei diesen Systemen steht das einfache Öffnen und Schließen der Tür sowie der schnelle Durchgang im Fokus – gleichzeitig sind sie einzelne Highlights in jedem Raum.

SCHIEBETÜRSYSTEM FÜR HOLZTÜREN CLASSIC 50/120

TÜRSYSTEME



Merkmale und Eigenschaften:

Trotz seiner geringen Abmessungen ist bei diesem Beschlag die komplette Technik in der Laufschiene integriert. Dieses System kann sowohl für die Wand- als auch für die Deckenmontage eingesetzt werden.

Höchste Laufruhe und einen sauberen und leichten Lauf garantiert der Laufwagen mit kugelgelagerten Laufrollen. Eine massive Bodenführung hält die Tür sicher in ihrer Spur.

Alle Systeme gibt es in ein- oder zweiflügeliger Ausführung in den Oberflächen Aluminium, Edelstahloptik oder Schwarz. Dazu passen Griffstangen oder Griffmuscheln in farblich abgestimmten Ausführungen.

Das Schiebetürsystem Classic 50/120 kann optional mit einem Anschlagkasten erweitert und die Schiebetür somit sogar verschließbar werden. Der optionale Softclose sorgt für das weiche und nahezu geräuschlose Schließen der Türen.

Technische Information:

- für Decken-* und Wandmontage
- für 8-10 mm Glasstärke
- Classic 50: Tragkraft bis max. 50 kg
- Classic 120: Tragkraft bis max. 120 kg

**nicht in Schwarz eloxiert*

Oberflächen:



Aluminium EV1 Edelstahloptik Schwarz eloxiert



Classic 50 mit Anschlagkasten

SCHIEBETÜRSYSTEM FÜR GLASTÜREN CLASSIC 50/120

TÜRSYSTEME



Auch für Glastüren

Die Schiebetürsysteme Classic 50 und 120 sind als ein- oder zweiflügelige Ausführung erhältlich sowie für die Wand- oder Deckenmontage geeignet. Zur Auswahl stehen Oberflächen in Aluminium, Edelstahloptik oder Schwarz.

Auch eine Kombination mit Ganzglastüren ist möglich, ebenso alle Optionen wie Softclose, Anschlagkasten und Griffvarianten. Mit einer Tragkraft bis zu 120 kg eignen sich Classic 120 Beschläge für größere Elemente und Classic 50 für kleiner dimensionierte Ausführungen.

Softclose für extraweichen Türeinzug:
Der Selbsteinzug „Softclose“ sorgt durch seinen gedämpften Endanschlag für Schutz und Komfort. Wie von selbst gleitet jede Tür in Position und wird weich gestoppt.





Glas-Schiebetüren mit Seitenteilen – System Classic 50/120

Für große Durchgänge und Wandöffnungen bietet dieses System eine lichtdurchlässige und platzsparende Alternative – ob im privaten Bereich oder im Office. Glastüren mit festem Seitenteil trennen Räume nicht nur voneinander, sondern sie sind in jedem Wohn- oder Bürobereich ein funktionales und optisches Highlight. Eine Vielzahl an klaren und matten Gläsern steht zur Auswahl – je nach individuellen Ansprüchen an Design, Licht und Durchblick.

Oberflächen:

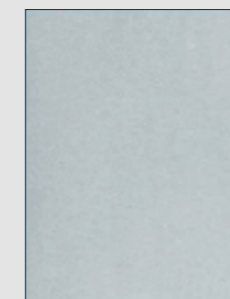

Aluminium EV1

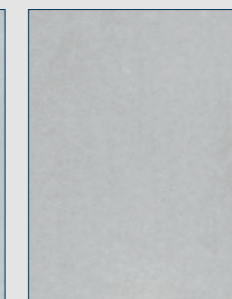

Edelstahloptik



Glas-Schiebetüren modern und exklusiv

Mit dem Schiebetürsystem Style 100 erhält jeder Raum ein unverwechselbares Gesicht. Das auffallende Punkthalter-Design und die sichtbaren Laufrollen sind charakteristisch für das gesamte System. Die ausgefeilte Technik, hochwertige Materialien und minimalistisches Design sorgen dafür, dass die Ästhetik und Dimensionen von Glastüren mit diesem System großzügig zur Geltung kommen. Neben doppelflügeligen Ausführungen ist eine Kombination mit allen Glassorten und -motiven möglich.

Technische Information:

- für 1- oder 2-flügelige Ganzglas-Schiebetüren
- für 8-10 mm Glasstärke
- Tragkraft bis max. 100 kg (je Flügel)
- Wandmontage





Basic 80 – das variable System

Dieser Schiebetür-Beschlag bietet mit seiner Bauform und Technik vielfältige Lösungen für jede Wandträger- und Einbausituation – ob verdeckt liegend zwischen zwei Wänden bei innenlaufenden Schiebetüren oder in Kombination mit Blenden bei vor der Wand laufenden Türen.

Basic 80 ermöglicht die optimale und effektive Produktkombination und -zusammenstellung von Schiebetürelementen. Zudem ist der Beschlag für die Montage an der Wand oder Decke, für ein- und zweiflügelige Türen einsetzbar und mit Einzugsdämpfung (Softclose) möglich.

Technische Information:

- in oder vor der Wand laufend
- Wand- oder Deckenmontage
- für 1- oder 2-flügelige Holz- oder Ganzglas-Schiebetüren
- für Holztüren bis 40 mm Stärke oder Glasdicke 8-10 mm
- Tragkraft bis max. 80 kg
- optional mit Softclose

PENDELTÜRSYSTEME PT60 + PT100

TÜRSYSTEME



Pendeltürband PT60:
Für Glastüren bis 60 kg
und max. 915 mm Breite.



Pendeltürband PT100:
Für Glastüren bis 100 kg
und max. 1200 mm Breite.

Freier Durchgang mit Pendeltüren

Die Türsysteme PT60 und PT100 sind auch als Glas-Pendeltürsysteme bekannt und häufig in der Gastronomie zu finden – zunehmend aber auch in Wohnräumen. Sie bieten ein leichtes Öffnen und Schließen der Tür sowie einen schnellen Durchgang in beide Richtungen. Die Tür pendelt dabei nach dem Öffnen automatisch in ihre Ausgangsposition zurück.

Die Beschläge PT60 und PT100 sind sowohl für die Montage direkt an der Laibung wie auch an einer Durchgangszarge geeignet und stehen in moderner Edelstahloptik zur Auswahl.

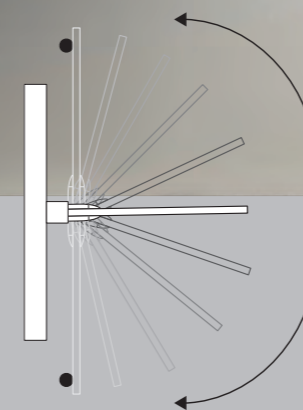

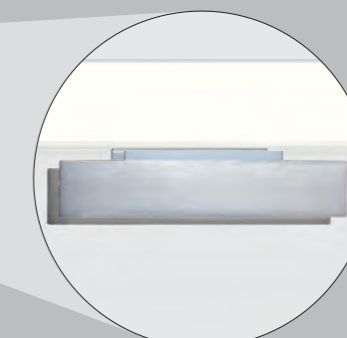

pushClose:
Ansicht Aufschlagseite



pushClose:
Ansicht Falzseite

Einfaches Öffnen und Schließen von Glastüren

Das Türsystem PCT40 ist die Kombination von Glastür, Beschlag PCT40, einer Zarge ohne Schließvorrichtung, Ganzglastür-Bändern und einem Stangengriff – eine neue Generation von Glas-Türelementen in moderner Optik und individueller Funktion.

Das Öffnen der Tür erfolgt dabei je nach Durchgangseite durch Anziehen oder Anstoßen am Stangengriff, der Beschlag PCT40 sorgt für das automatische Schließen der Tür. Zudem dämpft der Beschlag die zufallende Glastür sanft in ihre Endposition. Bei Wohnraamtüren, in denen das Abschließen per Schlüssel eher stört, ist dieses System eine perfekte Alternative.



BESCHLÄGE

Auch Beschläge müssen zur Tür passen. Egal ob Türgriffe, Griffmuscheln, Griffstangen oder Türbänder – Beschläge sind nicht nur Zubehör, sondern die Details, die das Gesamtbild einer jeden Tür maßgeblich beeinflussen und abrunden.

Unser breites Sortiment an Beschlägen bietet eine Vielzahl an Designs passend zu jeder Tür – angefangen von runden und eckigen Formen bis hin zu ergonomischen und minimalistischen Ausführungen. Verschiedene Eloxal- und Oberflächenausführungen, in klassischem Edelstahl, modernem Variocolor (Materialmix), hochglänzendem Chrom oder kontrastreichen Schwarz, sorgen für einen farblichen Einklang zwischen Tür und Beschlag.

RUND | EDELSTAHL



RUND | ALU SILBERFARBIG



RUND | GLANZCHROM



RUND | MATTNICKEL

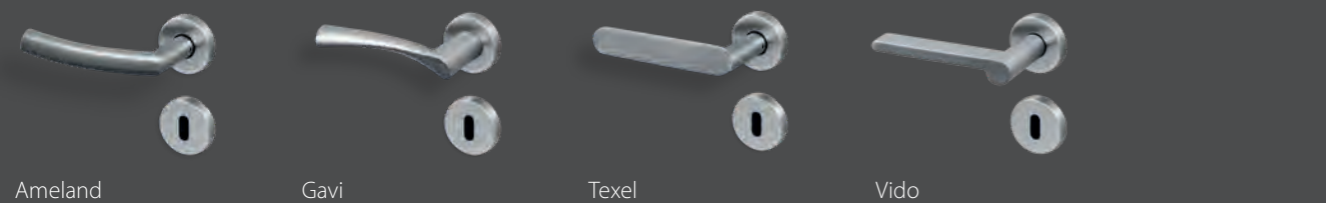

RUND | EDELSTAHL PREMIUM



RUND | VARIOCOLOR



RUND | SCHWARZ

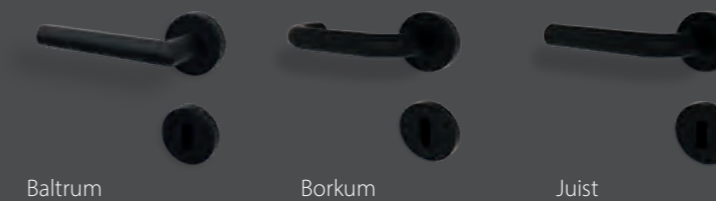



ECKIG | EDELSTAHL

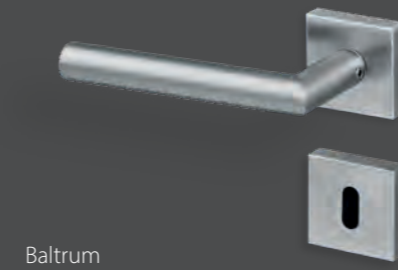

Baltrum



Paros



Rhodos

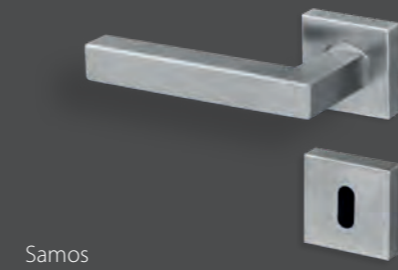

Samos

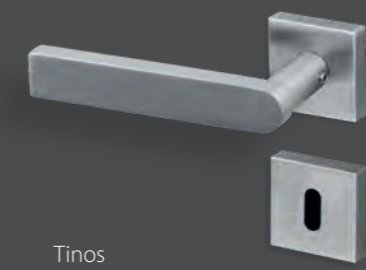

Tinos

ECKIG | VARIOCOLOR



Campo



Rocca



Lubi
Chrom/Mattnickel



Lubi
Chrom/Schwarz



TÜRGRIFFE
FLACHROSETTEN
BESCHLÄGE

RUND | EDELSTAHL



Baltrum Borkum Juist Norderney Langeoog



Helgoland Sylt Ilsa Jade Föhr



Ameland Gavi Texel Vido Paros



Rhodos Samos Tinos

RUND | VARIOCOLOR

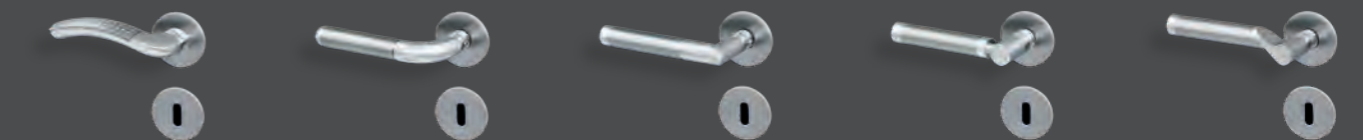

Anika Viva Menorca Ibiza Z Seville Z

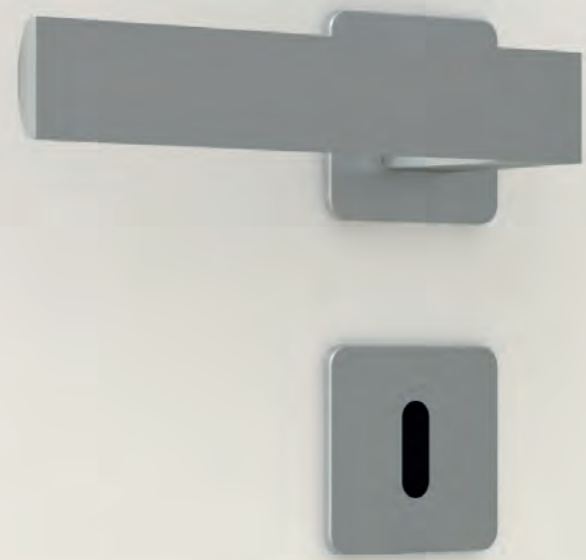

PURE | EDELSTAHL

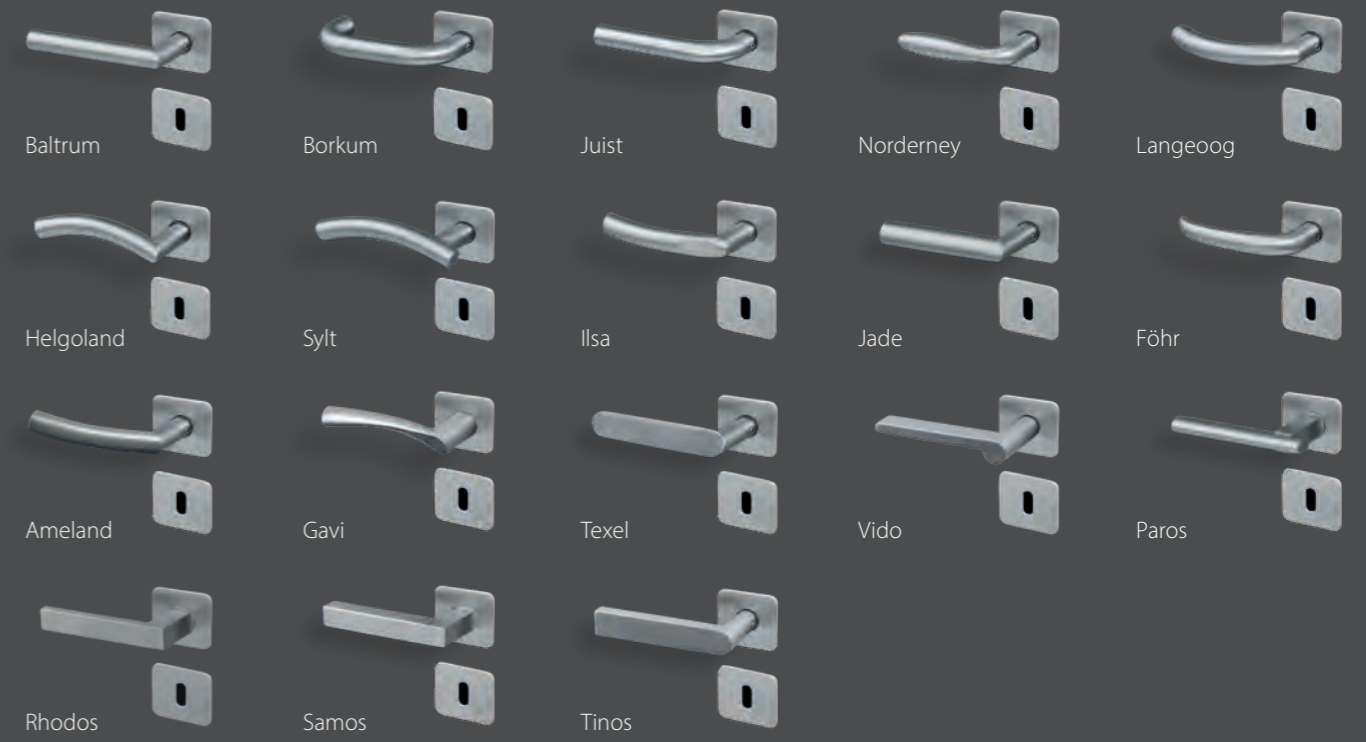

PURE | VARIOCOLOR



PURE MAGNO | EDELSTAHL

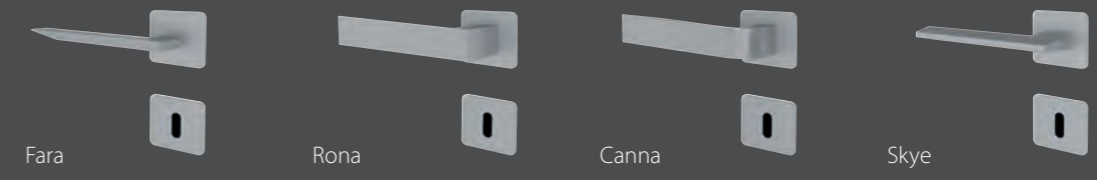

PURE MAGNO | SCHWARZ



RUND | EDELSTAHL



ECKIG | EDELSTAHL

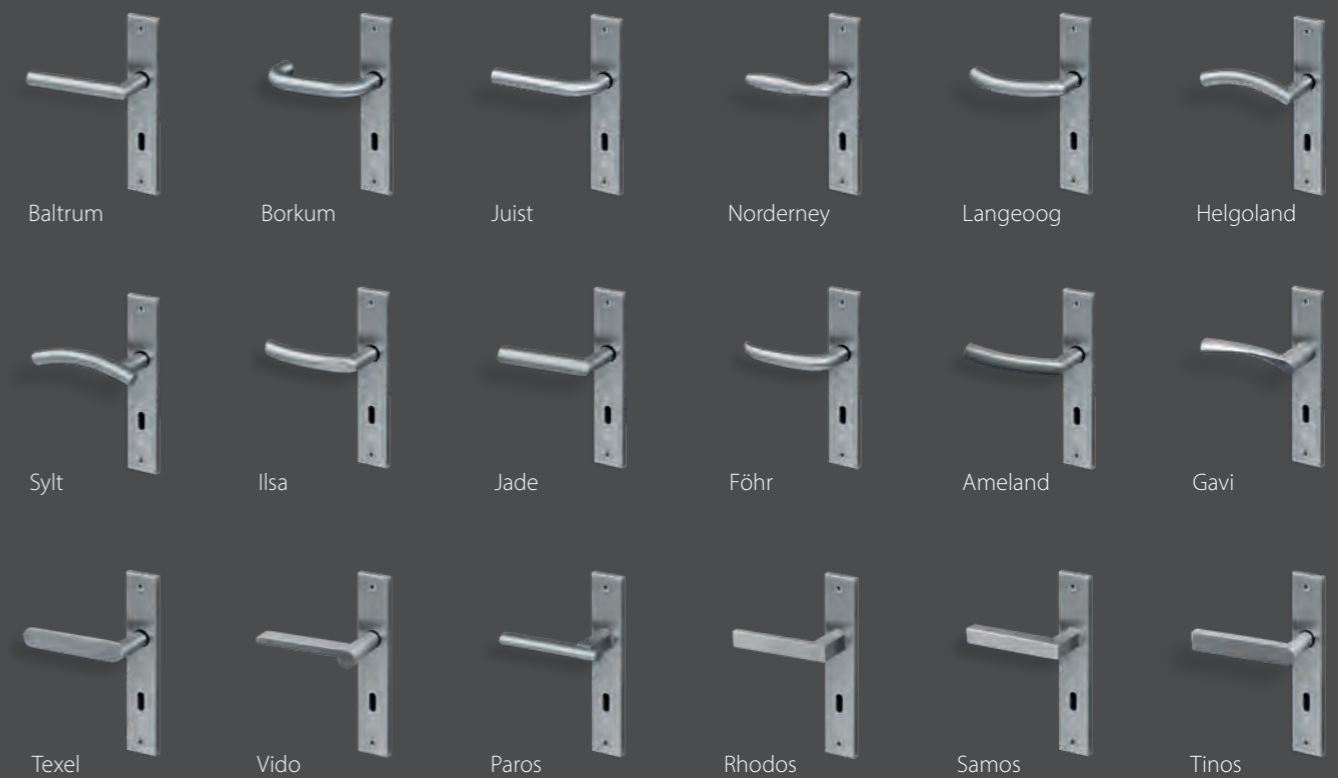

RUND | VARIOCOLOR



ECKIG | VARIOCOLOR



ECKIG DESIGN | MATTNICKEL



ECKIG DESIGN | GLANZCHROM



ANCONA

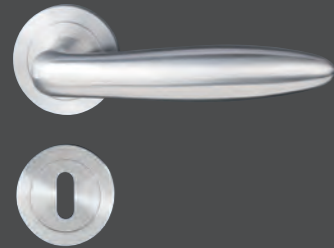

Edelstahl matt
Rosetten rund

BARI

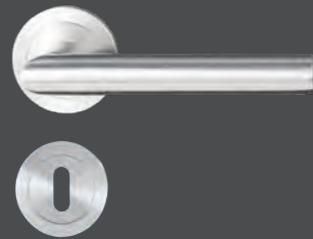

Edelstahl matt
Rosetten rund

BOZEN



Edelstahl matt/polier
Rosetten rund

BOZEN SQUARE



Edelstahl matt/polier
Rosetten eckig

FERRARA SQUARE

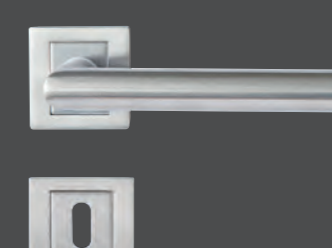

Edelstahl matt
Rosetten eckig

TORINO SQUARE



Nickel matt
Rosetten eckig

FERRARA

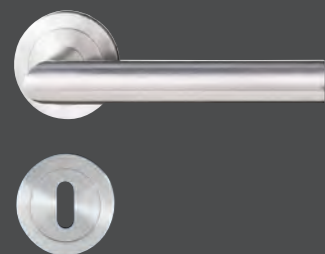

Edelstahl matt
Rosetten rund

GENUA

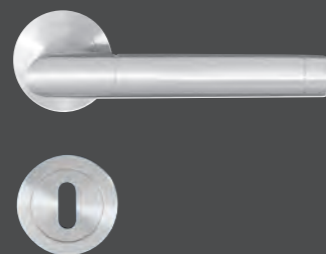

Edelstahl matt
Rosetten rund

GENUA II

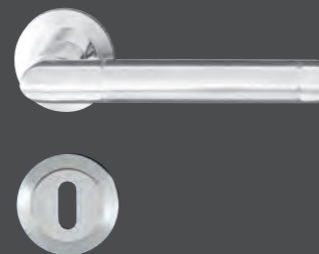

Edelstahl matt/polier
Rosetten rund

APART
FERRARA FLAT ROUND

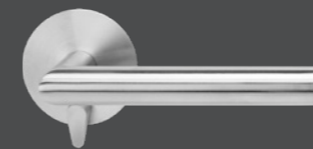

Edelstahl matt
Rosette rund

APART
MATERA FLAT ROUND

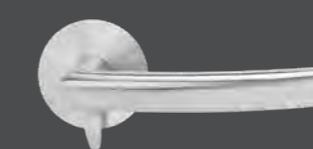

Edelstahl matt
Rosette rund

APART
FERRARA FLAT ROUND



PVD rauchschwarz
Rosette rund

MATERA

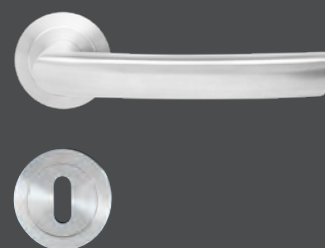

Edelstahl matt
Rosetten rund

SIENA II

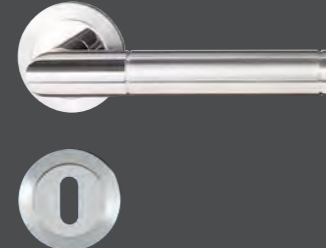

Edelstahl matt/polier
Rosetten rund

SALERNO



Edelstahl matt
Rosetten rund

APART
FERRARA FLAT SQUARE

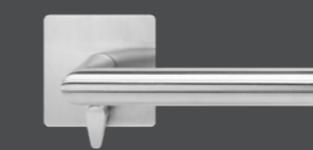

Edelstahl matt
Rosette eckig

APART
ABANO FLAT SQUARE



Edelstahl matt
Rosette eckig

APART
ABANO FLAT SQUARE

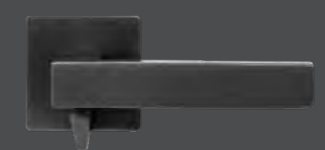

PVD rauchschwarz
Rosette eckig

Türgriffe der Serie APART zeichnen sich durch ihr minimalistisches Design aus. Obwohl hier auf Schlüsselrosetten komplett verzichtet wird, kann die Tür mittels einer integrierten Absperrvorrichtung an der Griffrosette trotzdem abgeschlossen werden.

POSEIDON - KERAMIK



Edelstahlfarbig satiniert
Rosetten rund



Edelstahlfarbig satiniert
Langschild



Chrom poliert
Rosetten rund



Chrom poliert
Langschild



Edelstahlfarbig satiniert
Rosetten rund



Edelstahlfarbig satiniert
Langschild



Chrom poliert
Rosetten rund



Chrom poliert
Langschild

SCARLET



Edelstahlfarbig satiniert
Rosetten rund



Edelstahlfarbig satiniert
Langschild



Chrom poliert
Rosetten rund



Chrom poliert
Langschild

MOUNT EVEREST



Edelstahlfarbig satiniert
Rosetten rund



Edelstahlfarbig satiniert
Langschild



Chrom poliert
Rosetten rund



Chrom poliert
Langschild

DESIGNGRIFFE RUND | SCHWARZ



Ronny II
Rosetten rund



Alaska II
Rosetten rund

DESIGNGRIFFE ECKIG | SCHWARZ

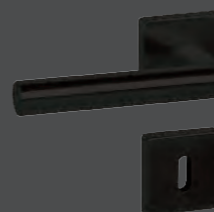

Ronny II Square
Rosetten eckig



Alaska II Square
Rosetten eckig

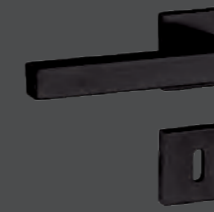

Galina II Square
Rosetten eckig



Malibu Square
Rosetten eckig



Prestige Quad
Rosetten eckig



Glory Quad
Rosetten eckig

MOUNT EVEREST | SCHWARZ



Rosetten rund



Langschild

SCHLOSSKÄSTEN & PASSENDE BÄNDER | EDELSTAHL

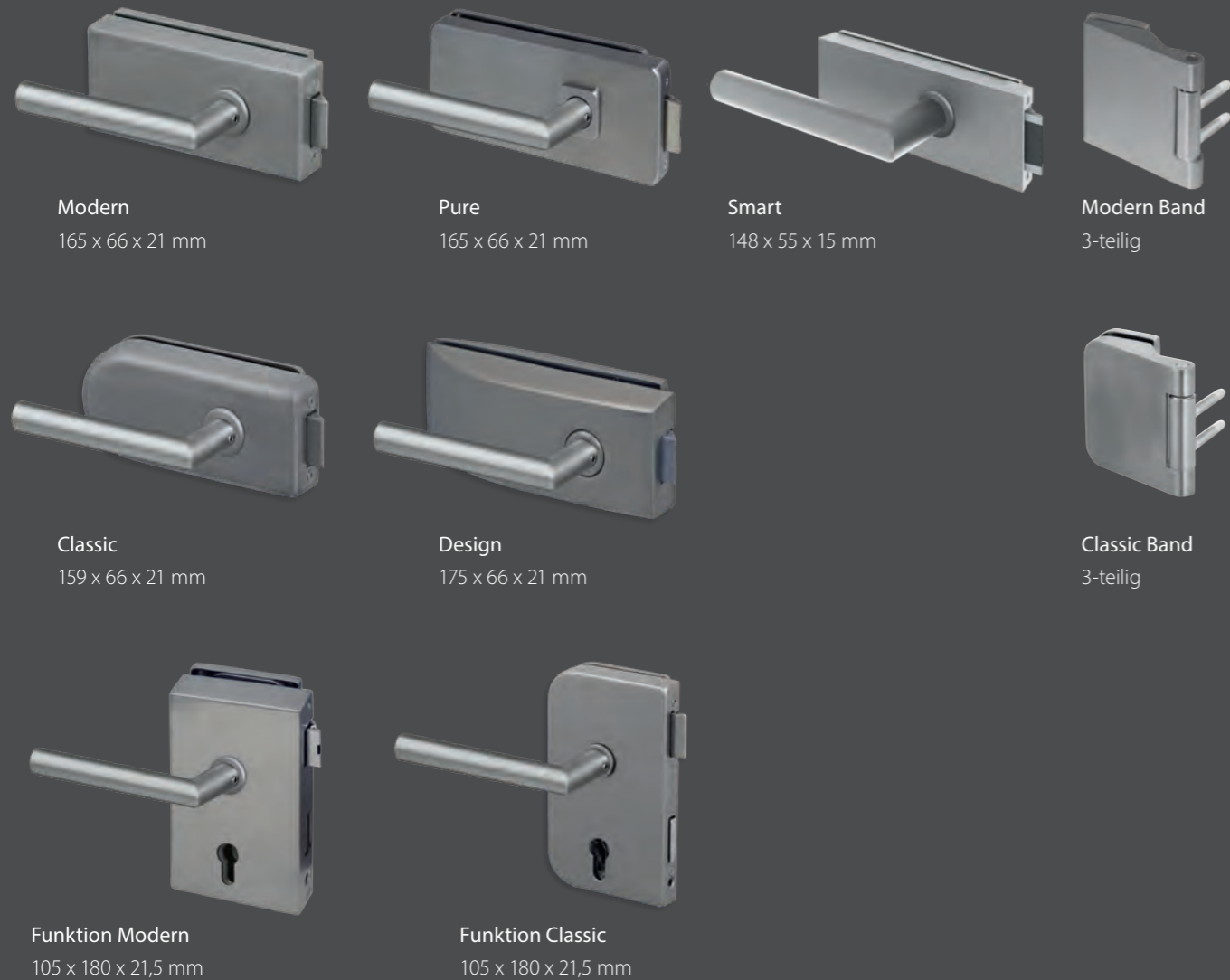

SCHLOSSKÄSTEN & PASSENDE BÄNDER | ALU SILBERFARBIG

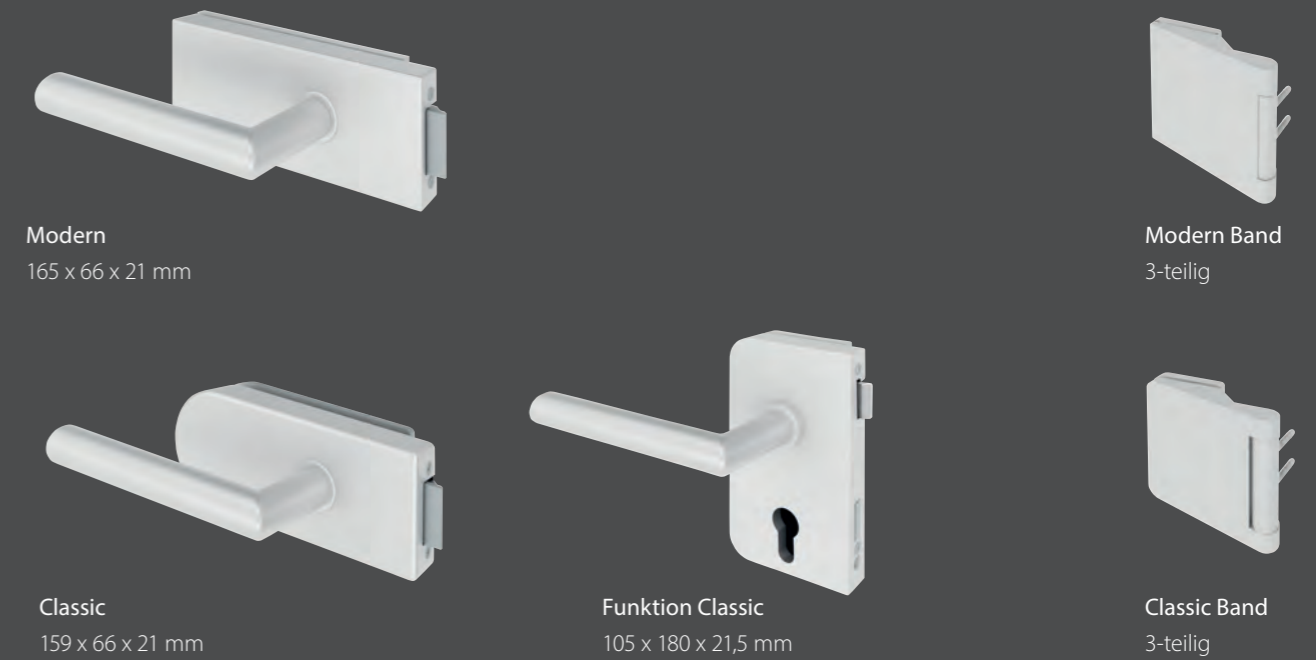

SCHLOSSKÄSTEN & PASSENDE BÄNDER | CHROM GLÄNZEND



Varianten WC-Verriegelungen



SCHLOSSKÄSTEN & PASSENDE BÄNDER | SCHWARZ





GRIFFSTANGEN EDELSTAHL FÜR HOLZ- UND GLASTÜREN

Viola
 rund – Ø 25 mm

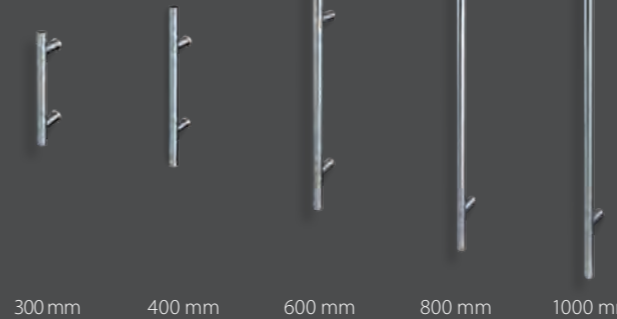

Ilaria
 eckig – 25 x 25 mm



Felia (Edelstahloptik)
 eckig – 25 x 25 mm



KOMBINATION GRIFFSTANGE/GRIFFLEISTE
 EDELSTAHOPTIK FÜR HOLZ- UND GLASTÜREN

Lola
 rund – Ø 25 mm
 Griffleiste 35 mm

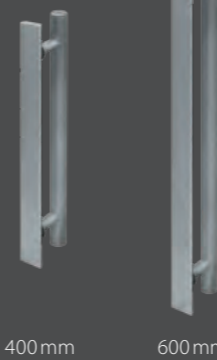

Livia
 eckig – 25 x 25 mm
 Griffleiste 35 mm

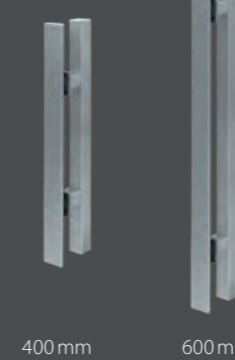

Elisa
 rund – Ø 25 mm
 Griffleiste 35 mm
 Griffmuschel geschlossen
 rund – Ø 65 mm



Stopper Edelstahl
 für 2-flügelige
 Glastürsysteme:



Paar für 2 Glastüren

GRIFFSTANGEN SCHWARZ
 FÜR HOLZ- UND GLASTÜREN

Viola
 rund – Ø 25 mm



Felia
 eckig – 25 x 25 mm



KOMBINATION GRIFFSTANGE/
 GRIFFLEISTE SCHWARZ FÜR
 HOLZ- UND GLASTÜREN

Lola
 rund – Ø 25 mm
 Griffleiste 35 mm



Livia
 eckig – 25 x 25 mm
 Griffleiste 35 mm

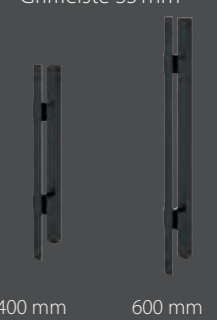

SCHIEBETÜRBESCHLÄGE GRIFFMUSCHELN

BESCHLÄGE

GRIFFMUSCHELN FÜR GLASTÜREN

Edelstahl



Chiara
rund 65 mm
geschlossen



Chiara
rund 65 mm
offen



Sofia
eckig 70 x 70 mm
geschlossen

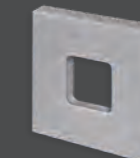

Sofia
eckig 70 x 70 mm
offen

Schwarz



Chiara
rund 65 mm
geschlossen



Sofia
eckig 70 x 70 mm
geschlossen

Alu silberfarbig



Chiara
rund 65 mm
geschlossen



Chiara
rund 65 mm
offen



Sofia
eckig 70 x 70 mm
geschlossen

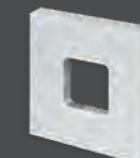

Sofia
eckig 70 x 70 mm
offen

Edelstahl poliert



Chiara
rund 65 mm
geschlossen

GRIFFMUSCHELN FÜR HOLZTÜREN

Edelstahl



Elena
oval
Edelstahl



Ariana
oval
Edelstahl



Mariela
50 mm



Leana
70 mm

rund geschlossen
Edelstahl



Zara
50 mm



Talia
70 mm

eckig geschlossen
Edelstahl



Felicia
70 mm

eckig-excent geschlossen
Edelstahl



Bianca
oval
45 x 155 mm



Bianca
oval
45 x 155 mm

Alu silberfarbig



Alesia
rund
75 mm



Camila
eckig
45 x 155 mm



Camila
eckig
45 x 155 mm



Vitoria
quadratisch
70 x 70 mm



Aurora
eckig/oval
Alu silberfarbig

Schwarz



Marta
rund
63 mm



Giada
quadratisch
57 x 57 mm



Valetia
eckig
63 x 210 mm



Stella
eckig/oval
41 x 120 mm



FUNKTIONEN & ERWEITERUNGEN

Für höhere Anforderungen und Ansprüche: Unser Türen-Sortiment bietet nicht nur Design- und Standardausführungen für Wohnräume, sondern auch eine Vielzahl an verschiedenen Funktionstüren und Erweiterungsmöglichkeiten.

Funktionstüren sind optisch kaum von normalen Türen zu unterscheiden, erfüllen allerdings durch einen anderen Aufbau und spezielle Ausstattungen technisch höhere Anforderungen. Je nach Einsatzgebiet in privaten oder geschäftlichen Räumen, gibt es für nahezu jeden Anspruch an Schall-, Einbruch-, Feuer- oder Rauchschutz sowie Feucht- oder Nassräume eine passende Variante im Sortiment.

UNSERE EINBRUCHHEMMENDEN ELEMENTE IM DETAIL:

Schützen, was einem lieb ist

Eine einfache und effiziente Möglichkeit Wohnungen und Häuser vor Einbrüchen zu schützen, ist der Einbau von einbruchhemmenden Türen. Zusätzliche Verriegelungen und ein stabiler Aufbau sorgen dabei für maximalen Schutz.

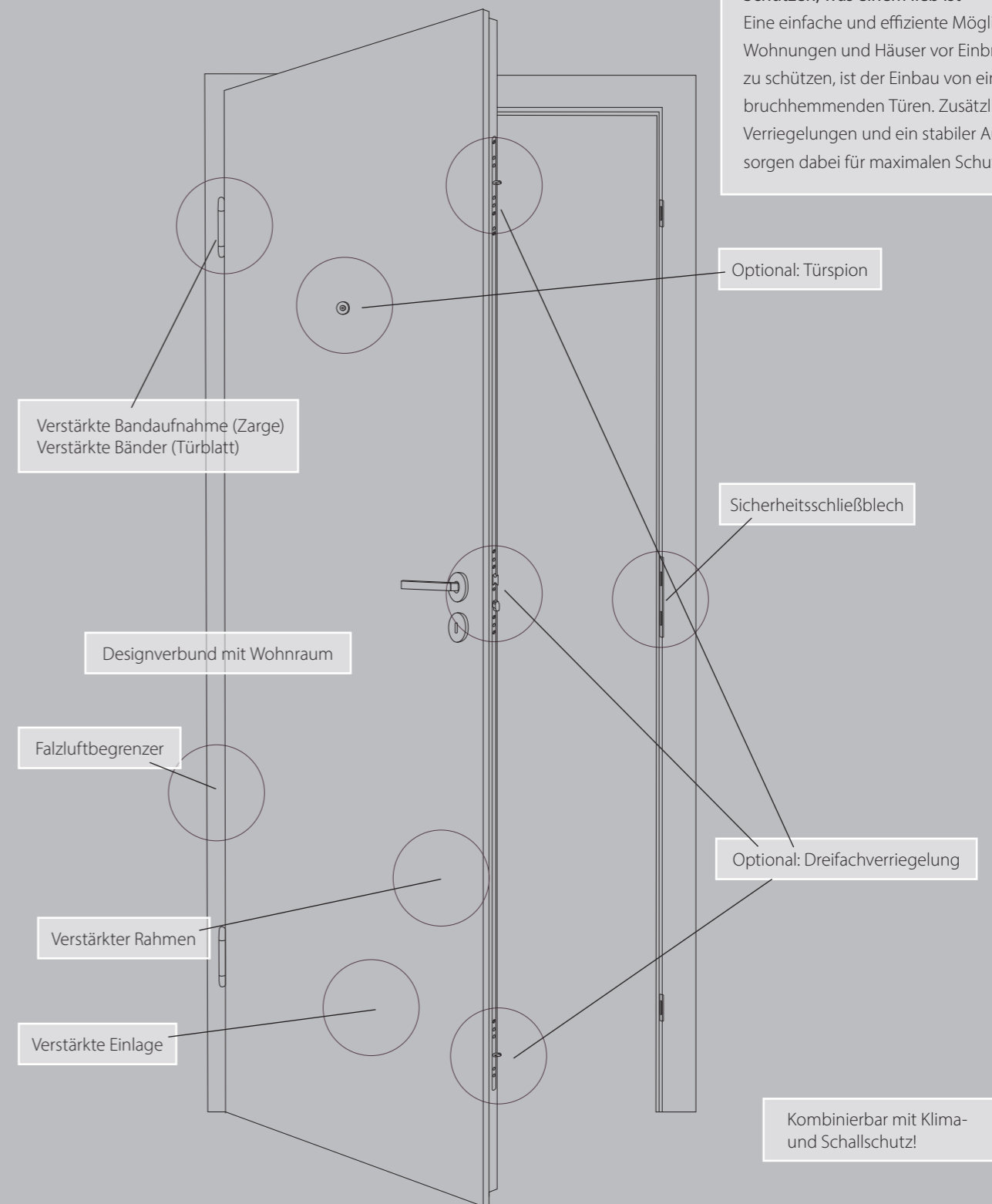

Prüfklimate gemäß DIN EN 1121

Prüfklimate		Geforderte Klimate			
RAL Klasse	DIN/EN	kalte Seite ❄️		warme Seite 🌡️	
		Lufttemperatur in °C	Rel. Feuchte (U) in %	Lufttemperatur in °C	Rel. Feuchte (U) in %
a/I	a	18°C ± 2°C	50% ± 5%	23°C ± 2°C	30% ± 5%
b/II	b	13°C ± 2°C	65% ± 5%	23°C ± 2°C	30% ± 5%
c/III	c	3°C ± 2°C	85% ± 5%	23°C ± 2°C	30% ± 5%

Einsatzempfehlungen – Schallschutz nach DIN 4109 Prüfwerten:

Schallschutzklasse I $R_{w,p} = 32$ dB:

- Mehrstöckige Wohn- und Bürogebäude
- Hausflure, Treppenhäuser, Flure von Wohnungen und Büros

Schallschutzklasse II $R_{w,p} = 37$ dB:

- Mehrstöckige Wohn- und Bürogebäude
- Hausflure, Treppenhäuser, direkter Wohnbereich/Büroraum
- Krankenhäuser und Pflegeheime
- Flure, Treppenhäuser, Untersuchungs- und Sprechzimmer, Krankenzimmer
- Hotels und Pensionen
- Flure, Übernachtungsräume
- Schulen und Unterrichtsbauten

Schallschutzklasse III $R_{w,p} = 42$ dB:

- Krankenhäuser und Pflegeheime
- Flure, Treppenhäuser, Untersuchungs- und Sprechzimmer

UNSERE SCHALLSCHUTZTÜREN IM DETAIL:

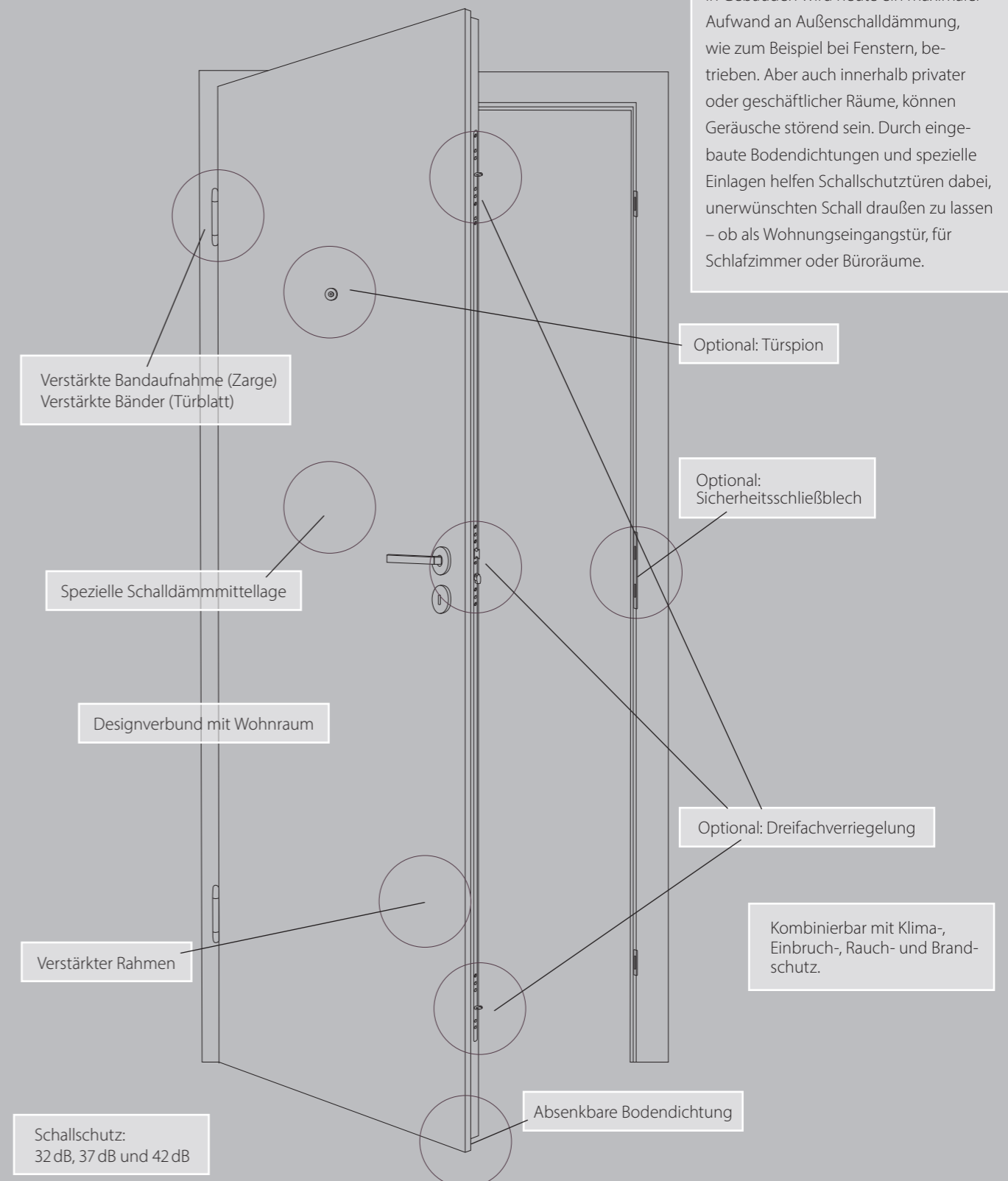

UNSERE RAUCH- UND FEUERSCHUTZTÜREN IM DETAIL:

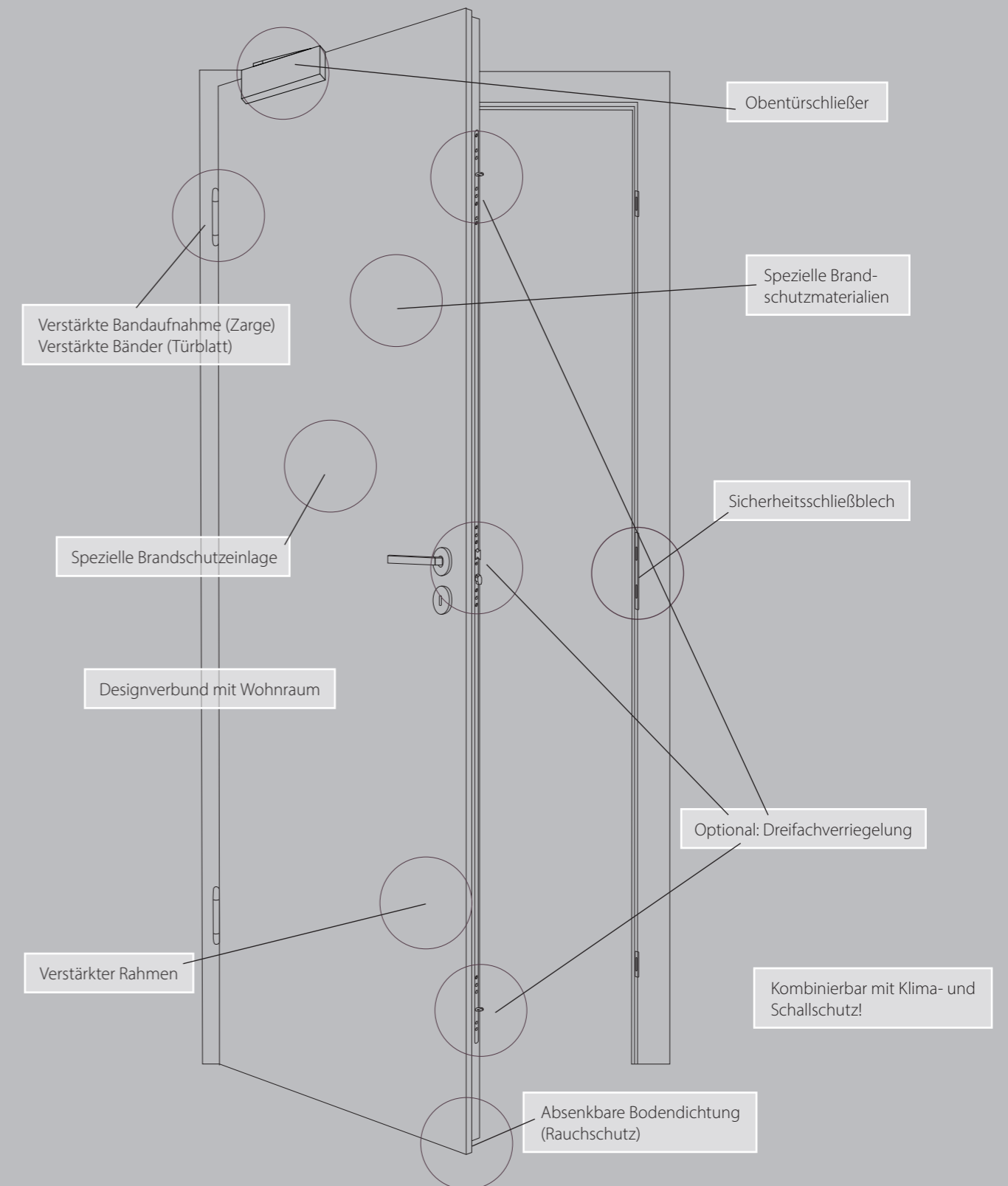

Mehr Sicherheit gegen Rauch und Feuer

Wo Menschen zusammenkommen steht Sicherheit an erster Stelle – ob Zuhause, bei der Arbeit in Hotels oder öffentlichen Gebäuden. Insbesondere gegen Rauch und Feuer gibt es im Bauwesen heutzutage hohe Schutzauflagen.

Unser Sortiment an geprüften Rauch- und Feuerschutztüren bietet dafür eine passende Lösung für nahezu alle Ansprüche und Auflagen.

Brandschutzstreifen

Unsere Brandschutztüren verfügen über einen aufschäumenden Brandschutzstreifen. Dieser wird aktiviert, wenn die Tür eine bestimmte Wärme- einwirkung bekommt. Daraufhin verkeilt sich die Tür in der Zarge. Dank dieser Technik wird verhindert, dass sich das Feuer schnell verbreiten kann.



Feuerwiderstandsklassen nach DIN 4102

Feuerwiderstandsklasse	Funktionserhalt über	deutsche bauaufsichtliche Benennung
T30	30 Minuten	feuerhemmend
T90	90 Minuten	feuerbeständig



UNSERE FEUCHT- UND NASSRAUMTÜREN IM DETAIL:

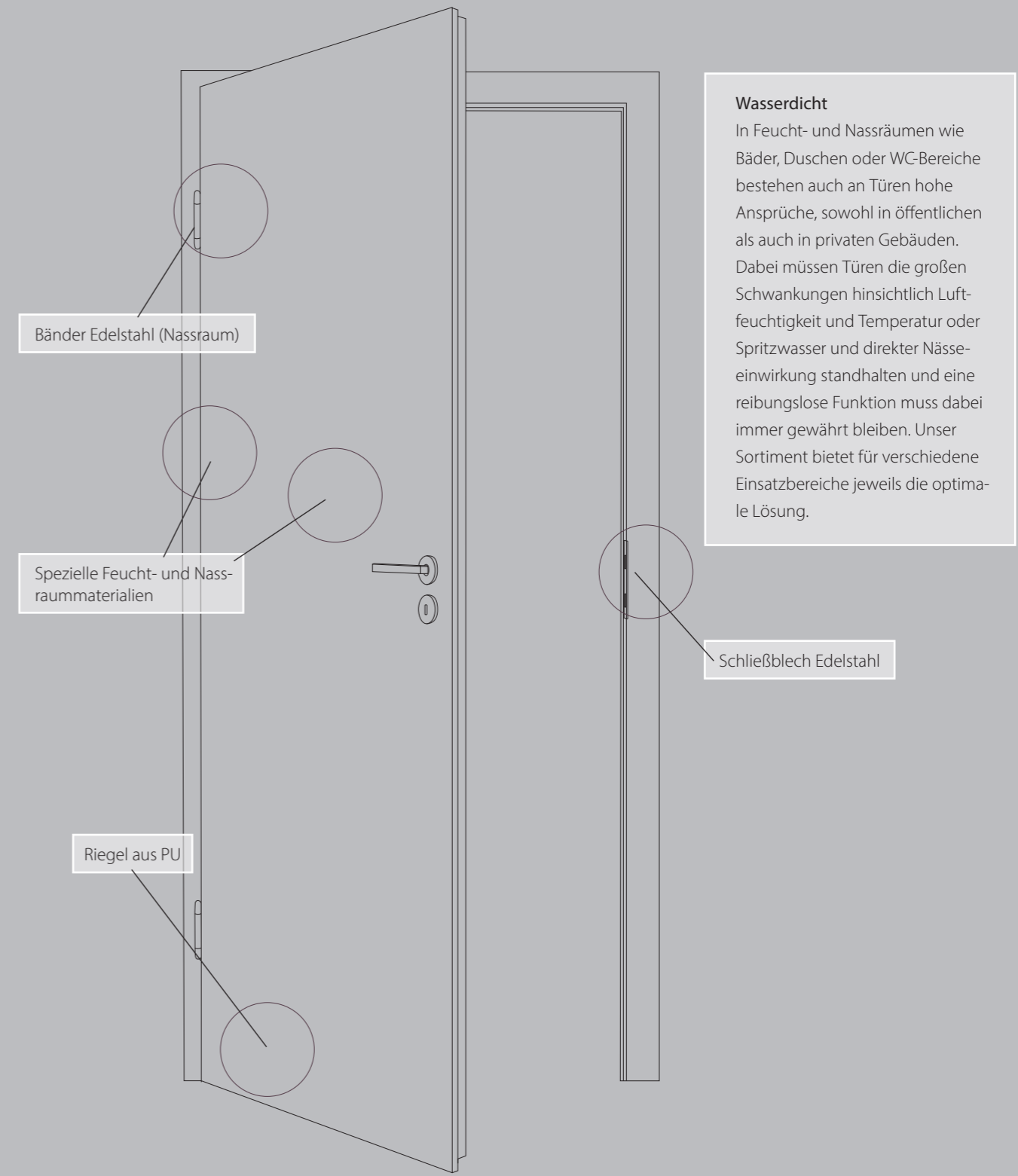



Schutzbeschläge



Schutz-Wechselgarnitur
Langschild rund



Schutz-Wechselgarnitur
Langschild rund mit Kernziehschutz



Schutz-Wechselgarnitur
Langschild rund mit Kernziehschutz
Innenseite Rosetten rund



Schutz-Wechselgarnitur
Langschild eckig



Schutz-Wechselgarnitur
Langschild eckig mit Kernziehschutz



Schutz-Wechselgarnitur
Langschild eckig mit Kernziehschutz
Innenseite Rosetten eckig

Designbänder

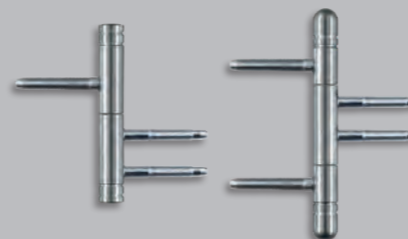

2-teilig
mit Flachkopf

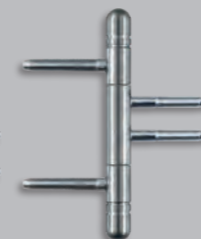

3-teilig
mit Rundkopf

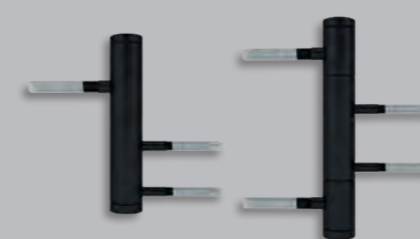

2-teilig
mattschwarz

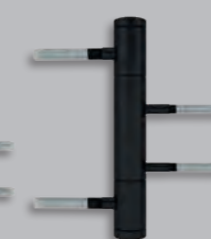

3-teilig
mattschwarz

Türbänder sind Designelemente

Die Varianten Flach- und Rundkopf gibt es jeweils in der Ausführung 2- oder 3-teilig in Edelstahl oder verchromt. Das schwarze Standardband ebenfalls als 2- oder 3-teiliges Band – immer passend zum Türgriff.

Bodentürstopper



Edelstahl rund



Edelstahl Muschel



Edelstahl eckig



Edelstahl rund



Edelstahl Muschel

Wandtürstopper



Edelstahl rund



Edelstahl rund
mit Garderobenhaken



Edelstahl eckig

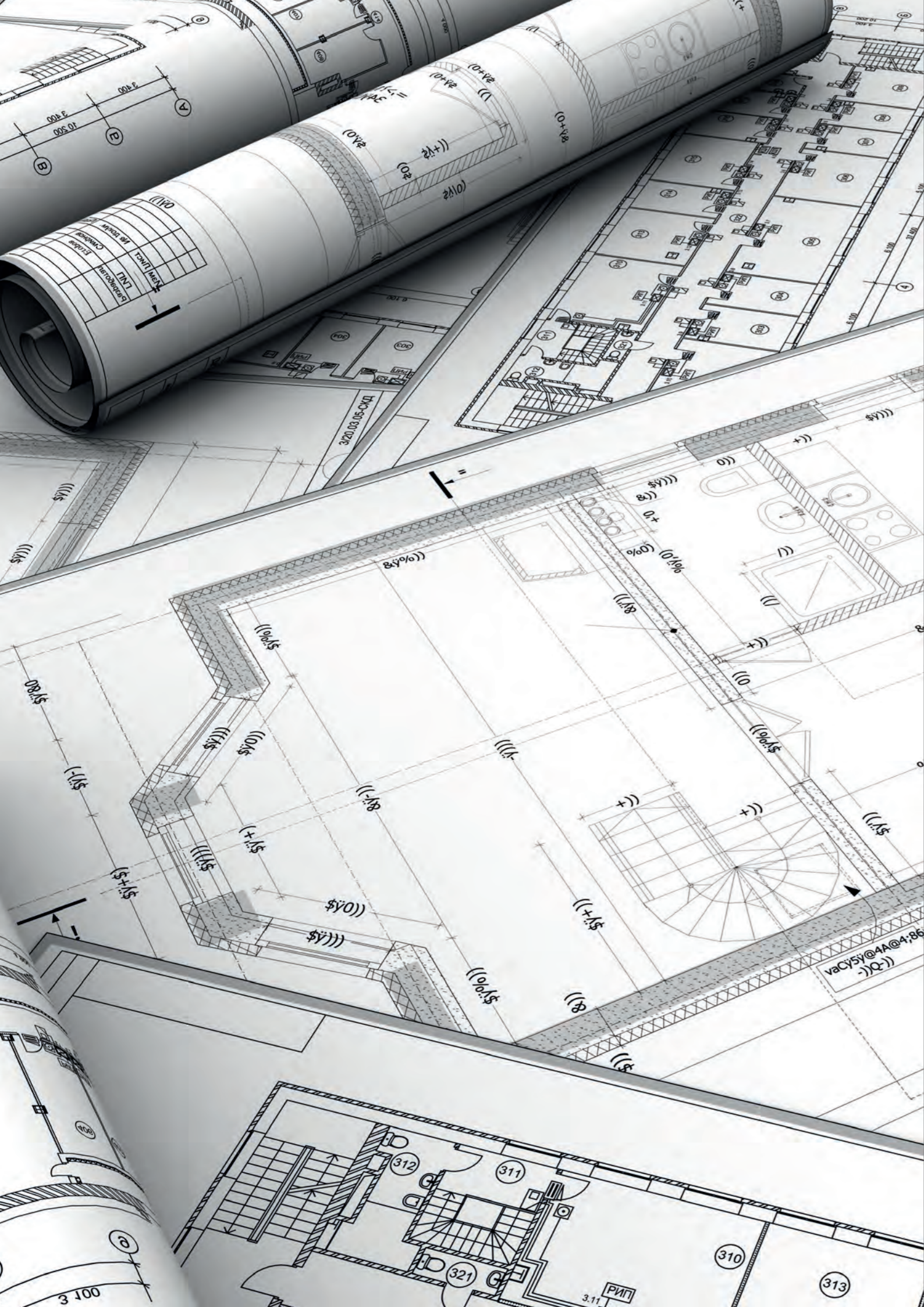

WISSENSWERTES

Innentüren sind außerordentlich vielfältig und bieten eine Vielzahl von Lösungen und Möglichkeiten. Neben den Standard-Türen und -Zargen gibt es eine Reihe an zusätzlichen Varianten, die allen individuellen Wünschen und Vorgaben gerecht werden können – wie zum Beispiel Türen und Zargen im Sondermaß, Windfangelemente mit Seitenteilen und Oberlicht oder Zargen als Blend- oder Blockrahmen.

Alle wichtigen Informationen zu Ausführungsmöglichkeiten, Oberflächen, Kanten, Zargenvarianten, Türen- und Zargenkombinationen, sowie technische Hilfen, sind auf den Folgeseiten dargestellt.

Weißlack

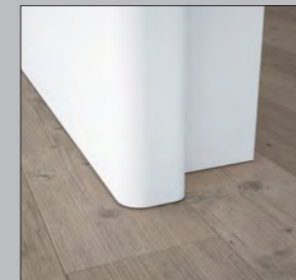

Rundkante | Runde Optik
Verfügbar für: Weißlack 1.0 | Kiel | Salerno



Designkante | Eckige Optik
Verfügbar für: Weißlack 3.0 | Weißlack 1.0 Genua | Bergamo | Lübeck | Salerno | Flensburg



Eckkante | Eckige Optik
Verfügbar für: Weißlack 1.0 | Verona | Siena | Modena | Novara



Karnieskante
Verfügbar für: Weißlack 1.0 | Kopenhagen

Mineralgrau



Designkante | Eckige Optik
Verfügbar für: Mineralgrau | Florenz | Roma | Hamburg

Designoberflächen



Designkante | Eckige Optik
Verfügbar für: CPL Klassik | CPL Struktura | CPL Mattline | CPL Colour

Furnier



Eckkante | Eckige Optik
Verfügbar für: Furnier Klassik | Furnier Asteiche | Furnier Plankeneiche | Furnier Finline

Türblatteinlagen

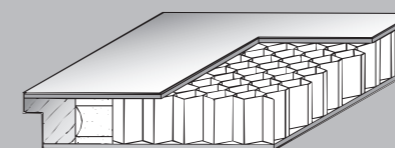

Wabeneinlage

Das Türblatt ist gefüllt mit einer engmaschigen Karton-Wabe, die für Zimmertüren eine ausreichende Stabilität bringt. Durch ihre Bauweise ist diese Tür sehr leicht und somit einfach zu handhaben.

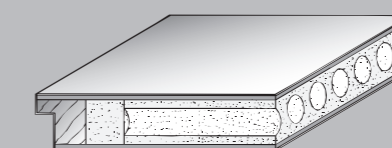

Röhrenspanplatte

Eine Tür mit Röhrenspanplatte hat eine hohe Stabilität und hält somit auch gehobeneren Ansprüchen stand. Sie verleiht den Türen eine hohe Flächenstabilität und Oberflächenruhe.

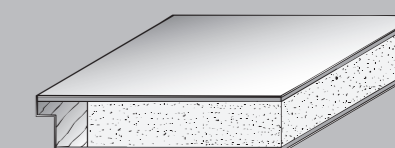

Vollspanplatte

Türen mit einer Mittellage aus Vollspan finden ihren Einsatz vor allem im Bereich Schallschutz oder Klimaschutz. Auch Wohnungseingangstüren verfügen meist über eine Vollspan-Einlage.

Weißlack 1.0



Rundkante
Bekleidungsbreiten: 60 mm | 80 mm



Designkante
Bekleidungsbreite: 70 mm



Duoline
Bekleidungsbreite: 75 mm



Profil B1
Bekleidungsbreite: 65 mm



Profil C1
Bekleidungsbreite: 70 mm



Profil D1
Bekleidungsbreite: 90 mm

Weißlack 3.0



Designkante
Bekleidungsbreite: 70 mm

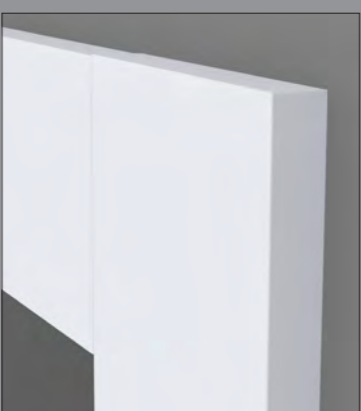

Duoline
Bekleidungsbreite: 75 mm

Mineralgrau



Designkante
Bekleidungsbreite: 60 mm

Designoberflächen



Designkante
Bekleidungsbreiten: 60 mm | 80 mm

Furnier



Eckkante
Bekleidungsbreite: 60 mm



ÜBERSICHT BLEND-/BLOCKRAHMEN

ZARGEN

Blockrahmen

Zwischen zwei Wänden an beliebiger Position angebracht, hilft der Blockrahmen in unterschiedlichsten Ausführungen, einen Durchgang zu verschließen. Ob nur mit einer Tür in der Laibung oder mit Seitenteil oder Oberlicht als Abtrennung in einem Flur, es sind kaum Grenzen gesetzt. Blockrahmen sind in Weißlack sowie vielen Design- und Echtholzoberflächen verfügbar.



Blendrahmen

Überall da, wo eine normale Umfassungszarge nicht eingesetzt werden kann, hilft eine Blendrahmenezarge weiter, zum Beispiel an Einbauwänden mit sehr geringer Wandstärke. Sie wird einseitig auf die Wand aufgeschraubt und verblendet die Wand. Die Funktionsweise steht dabei einer Umfassungszarge in nichts nach.



Standardzargen

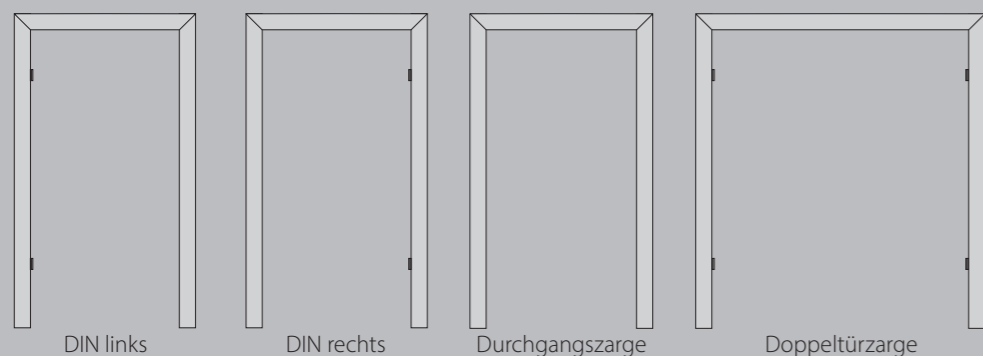

Oberlichtzargen

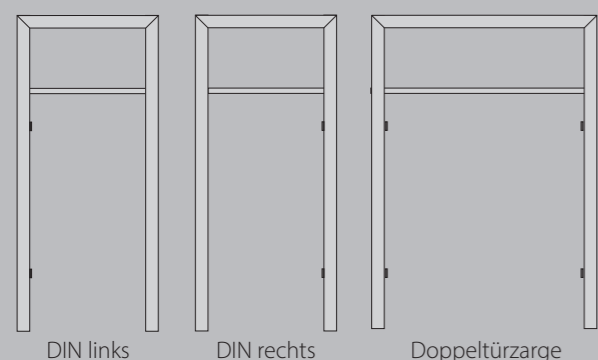

Seitenteilzargen (Windfangzargen) sind als Umfassungs- oder Blockrahmenzarge erhältlich.

Seitenteilzargen

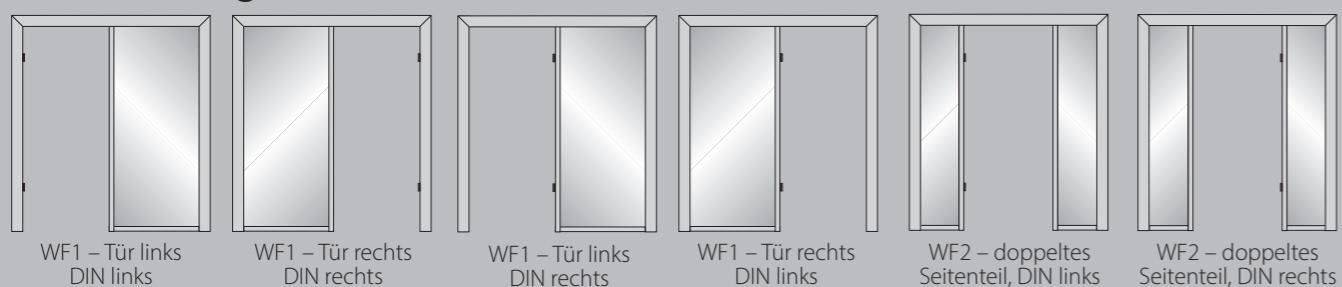

Oberlichtzargen mit Seitenteil:

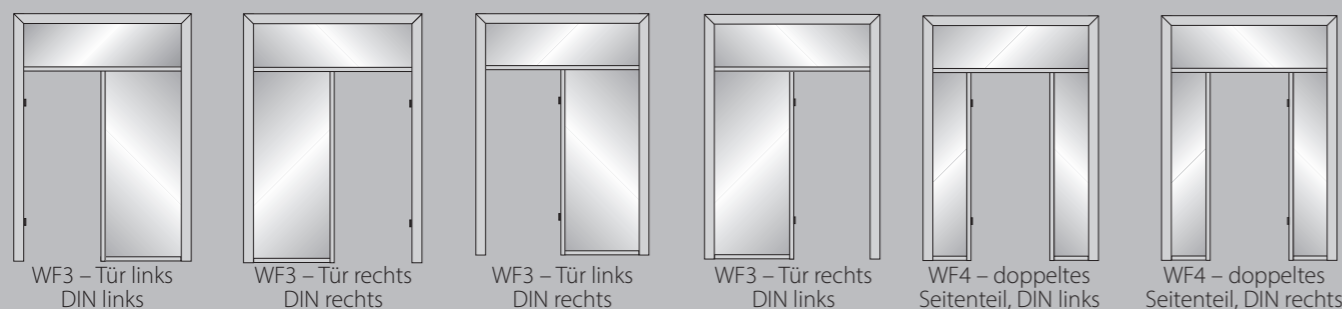

Schiebetürzargen



Anschlagrichtung

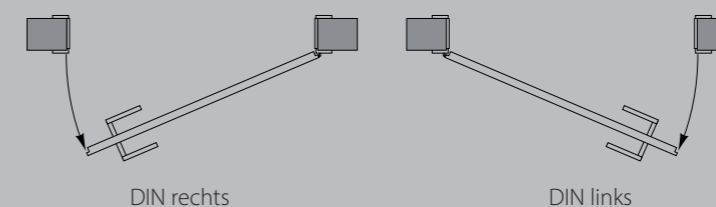

Querschnitte Zargen

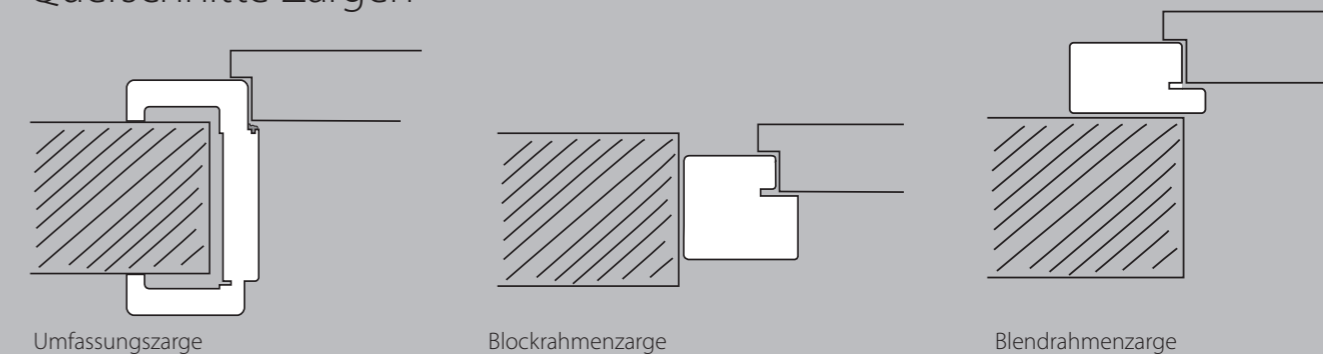



Weißlack 1.0

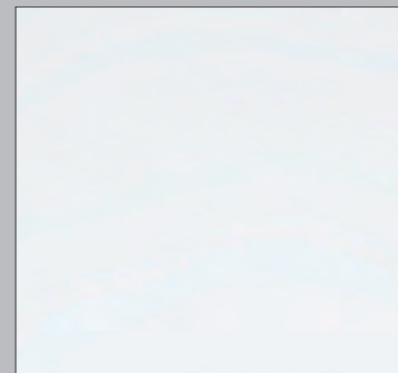

Weißlack 1.0

Weißlack 3.0

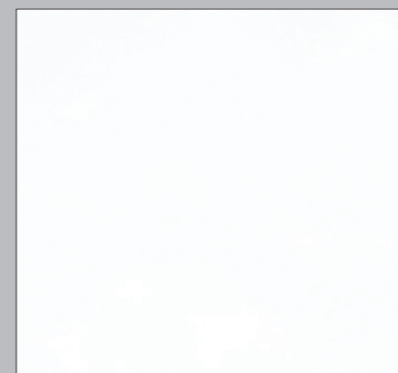

Weißlack 3.0

Designoberflächen

CPL Klassik



Esche weiß deckend

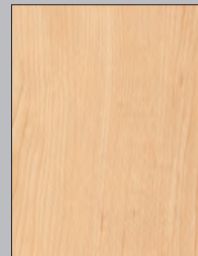

Ahorn



Buche



Akazie



Eiche natur

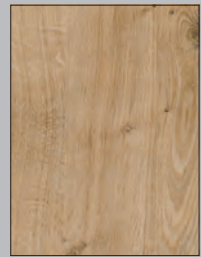

Eiche astig



Eiche astig quer

CPL Mattline



Brillantweiß



Lichtgrau

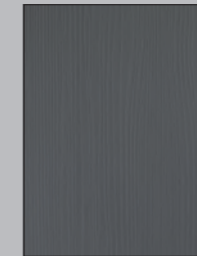

Mineralgrau



Eiche Platingrau

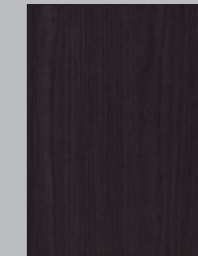

Eiche Graphitgrau



Brillantweiß quer



Lichtgrau quer

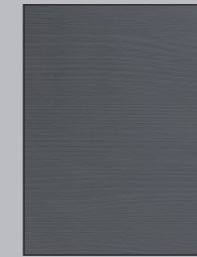

Mineralgrau quer



Eiche Platingrau quer

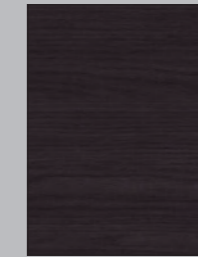

Eiche Graphitgrau quer

CPL Struktura



Pinie Ivory

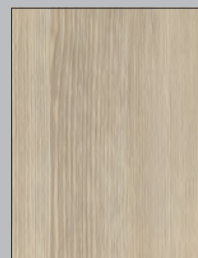

Pinie Cream



Pinie Silvergrey



Fachwerk Eiche Sand



Fachwerk Eiche Natur



Fachwerk Eiche Honig



Pinie Ivory quer

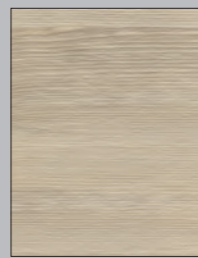

Pinie Cream quer



Pinie Silvergrey quer



Fachwerk Eiche Sand quer



Fachwerk Eiche Natur quer



Fachwerk Eiche Honig quer

CPL Colour

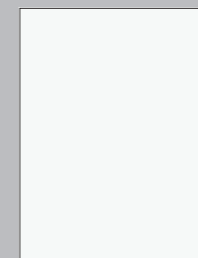

Uni weiß



Uni grau

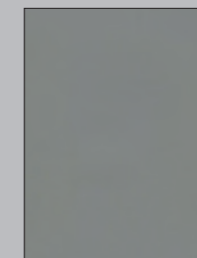

Arktisgrau



Onyxgrau

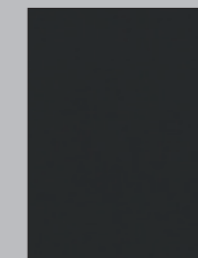

Anthrazitgrau

Furnier

Furnier Klassik



Ahorn Buche Eiche Hell Eiche Natur Eiche Rustikal Macore



Limba Amerik. Nussbaum Mahagoni

Furnier Plankeneiche



Natur Natur geölt Creme Bronze



Natur quer Natur geölt quer Creme quer Bronze quer

Furnier Asteiche



Natur Natur geölt Creme Bronze

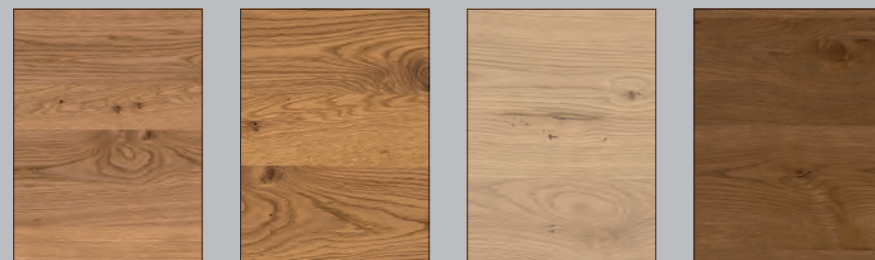

Natur quer Natur geölt quer Creme quer Bronze quer

Furnier Fineline



Grey Darkgrey Beige Caramel Tabacco



Grey quer Darkgrey quer Beige quer Caramel quer Tabacco quer

Die wichtigsten Maße auf einen Blick

(Darstellung: Gefälztes Türelement)

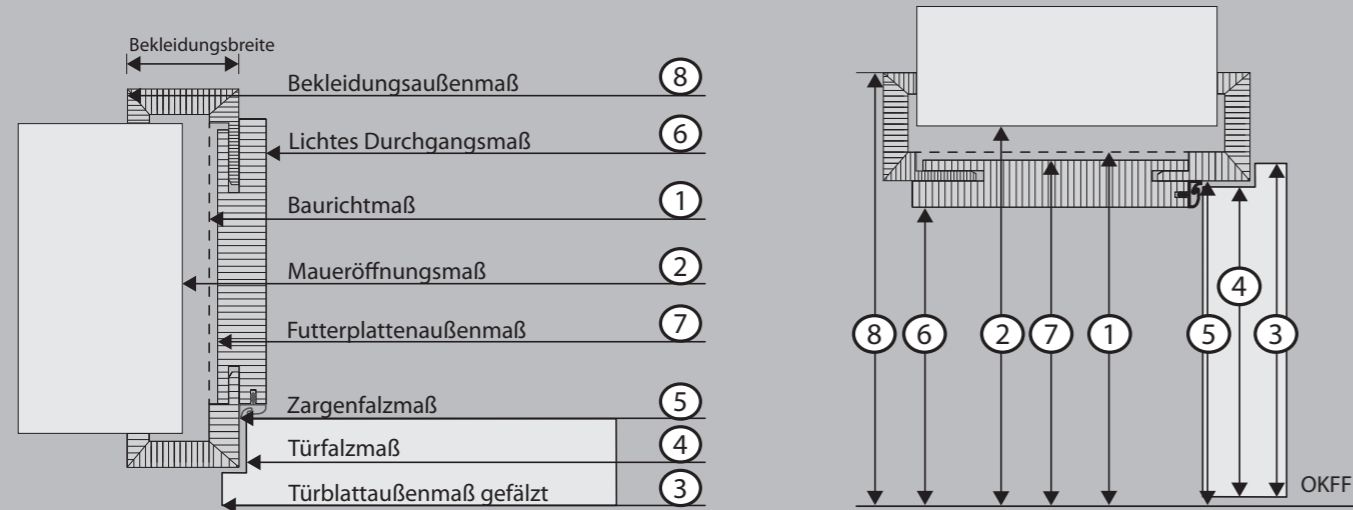

Erläuterungen:

OKFF = die planmäßige Lage der Oberfläche des Fertigbodens, zum Beispiel: die Oberfläche eines PVC-Belages über Spachtelmasse, Estrich, Trittschalldämmung und Ausgleichsestrich über der Rohdecke.

Dargestellt ist die Maueröffnung im Querschnitt mit aufgesetzter Zarge und einem Teil des aufschlagenden Türblattes. Die relevanten Maße sind durchnummeriert und finden sich rechts in der Tabelle wieder.

Tabelle

		Türblatt- außenmaße		Zargenmaße										
		Bau- richtmaß nach DIN 18100	Mauer- öffnungs- maß ¹⁾	Türblatt- außen- maß gefälzt	Türfalz- maß	Zargen- falzmaß	lichtes Zargen- durch- gangs- maß	Futter- platten- außen- maß	Bekleidungsaußenmaß					
									Bekleidungsbreite					
									60 mm	65 mm	70 mm	75 mm	80 mm	90 mm
①	②	③	④	⑤	⑥	⑦	⑧	⑧	⑧	⑧	⑧	⑧		
1-flügelige Türen	Breite	625	635	610	584	591	567	613	711	721	731	741	751	771
		750	760	735	709	716	692	738	836	846	856	866	876	896
		875	885	860	834	841	817	863	961	971	981	991	1001	1021
		1000	1010	985	959	966	942	988	1086	1096	1106	1116	1126	1146
		1125	1135	1110	1084	1091	1067	1113	1211	1221	1231	1241	1251	1271
1-flügelige Türen	Höhe	1875	1885	1860	1847	1855	1843	1865	1915	1920	1925	1930	1935	1945
		2000	2010	1985	1972	1980	1968	1990	2040	2045	2050	2055	2060	2070
		2125	2135	2110	2097	2105	2093	2115	2165	2170	2175	2180	2185	2195
		2250	2260	2235	2222	2230	2218	2240	2290	2295	2300	2305	2310	2320

2-flügelige Türen	Breite	1250	1260	1210	1184	1191	1167	1212	1311	1321	1331	1341	1351	1371
		1500	1510	1460	1434	1441	1417	1462	1561	1571	1581	1591	1601	1621
		1750	1760	1710	1684	1691	1667	1712	1811	1821	1831	1841	1851	1871
		2000	2010	1960	1934	1941	1917	1962	2061	2071	2081	2091	2101	2121
		2250	2260	2210	2184	2191	2167	2212	2311	2321	2331	2341	2351	2371
2-flügelige Türen	Höhe	1875	1885	1860	1847	1855	1843	1865	1915	1920	1925	1930	1935	1945
		2000	2010	1985	1972	1980	1968	1990	2040	2045	2050	2055	2060	2070
		2125	2135	2110	2097	2105	2093	2115	2165	2170	2175	2180	2185	2195
		2250	2260	2235	2222	2230	2218	2240	2290	2295	2300	2305	2310	2320

1) Hinweise zum Maueröffnungsmaß:

Aufgrund der heute üblichen Beschlagtechnik bei Holz-zargen hat es sich bewährt, die tatsächliche Maueröffnung etwa 10 bis 15 mm breiter zu erstellen, als sich nach DIN 18100 ergäbe. Man vermeidet so in aller Regel eventuell notwendige Nachstemarbeiten im Bereich der Zargenbeschläge.

Bei stumpfeinschlagenden (den so genannten flächenbün-digen Türelementen) ist die Vergrößerung der Maueröffnung in der Breite um 15 mm aufgrund der verdeckten Beschläge zwingend notwendig.

Fenster & Türen Welt®

| MEHR ALS 3000 QUADRATMETER |

Fenster & Türen Welt®



FENSTER | ALU-FENSTER | HOLZ-FENSTER | TÜR



Fenster & Türen Welt
 Göttinger Str. 10
 Im Park & Schloss-Center
 38102 Helmshausen
 Telefon: 0541.4991-0
 E-Mail: info@fwelt.de

Öffnungszeiten
 Mo - Mi 10:00 - 18:00 Uhr
 Do - Sa 10:00 - 18:00 Uhr

Fenster & Türen Welt
 Göttinger Str. 10
 Osterode am Harz
 38102 Osterode am Harz
 Telefon: 0541.4991-0
 E-Mail: info@fwelt.de

Öffnungszeiten
 Mo - Mi 10:00 - 18:00 Uhr
 Do - Sa 10:00 - 18:00 Uhr

Fenster & Türen Welt®

**WIRTSCHAFTSUNIVERSITÄT
 WIRTSCHAFTSINFORMATIK
 WIRTSCHAFTSRECHT**